

Please Note

The Above is a Selection of the Most Popular Straight Run Configurations.
 These are Available Either Open Out or Open In.
 The ● Configurations Can Also Be Supplied Opposite Hand.
 Corner and Faceted Curved Options are Also Available

Description **SF50***

**Thermally Broken Aluminium Folding Sliding Door System
 Configuration Options**

Detail No: **SF50-00**

System: **SF50** **A**

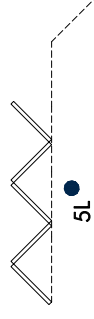
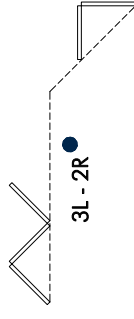
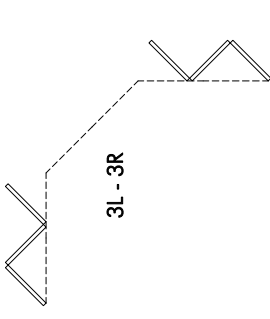
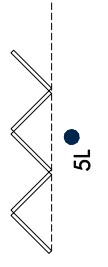
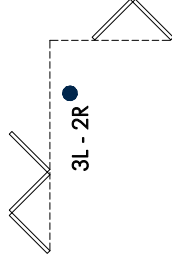
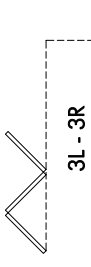
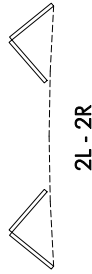
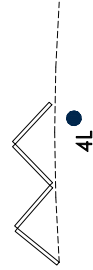
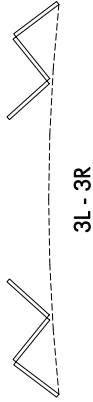
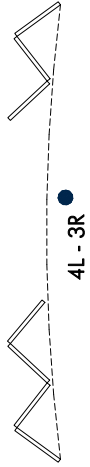
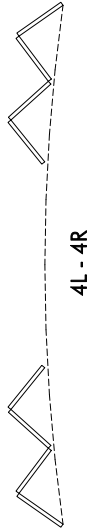
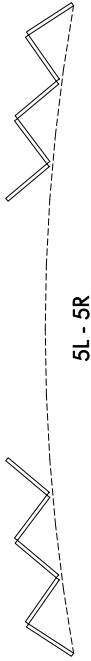

Please Note
The Above is a Selection of Corner and Faceted Curved Options.
These are Available Either Open Out or Open In.
The ● Configurations Can Also Be Supplied Opposite Hand.

Description **SF50**

Thermally Broken Aluminium Folding Sliding Door System
Special Configuration Options

Detail No: **SF50-00 B**

System: **SF50** **A**

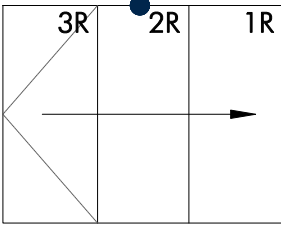

OUTSIDE

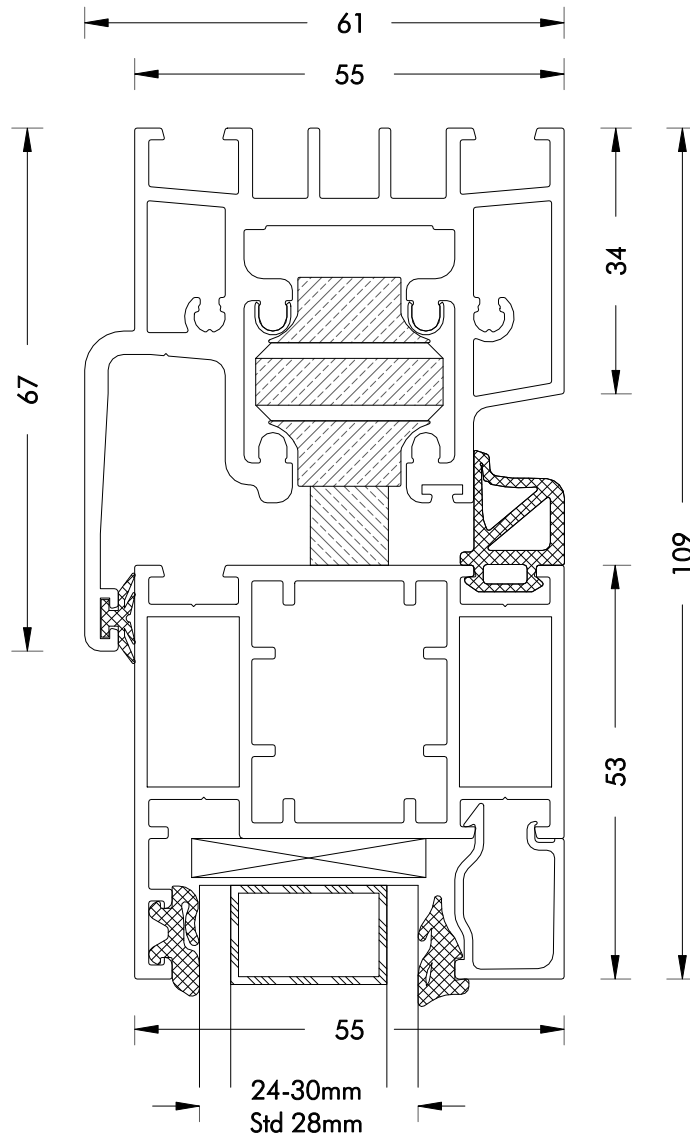

INSIDE

Description **Vertical Section - Connection**
Top Track - Panel / Open In

Detail No: **SF50-01**

System: **SF50**

A

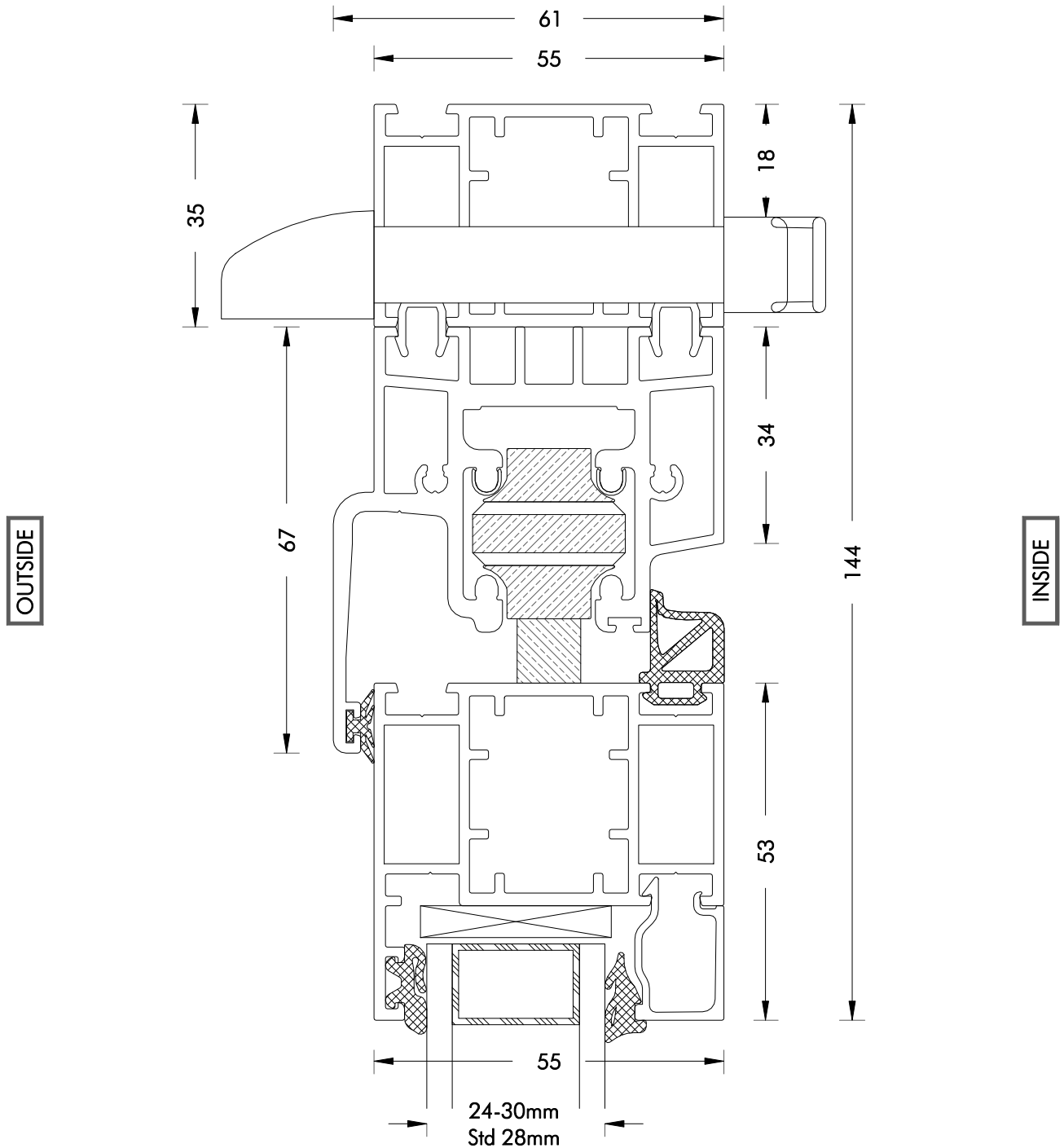
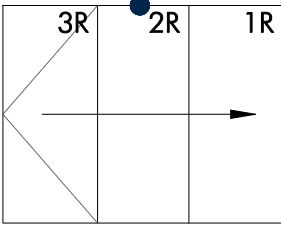

Description **Vertical Section - Connection**
Top Track With 35mm Extension And Trickle Vent - Panel /
Open In

Detail No: **SF50-01TV**

System: **SF50**

A

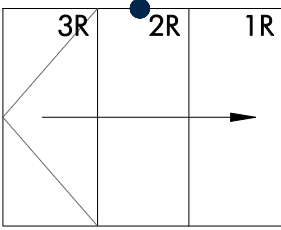

OUTSIDE

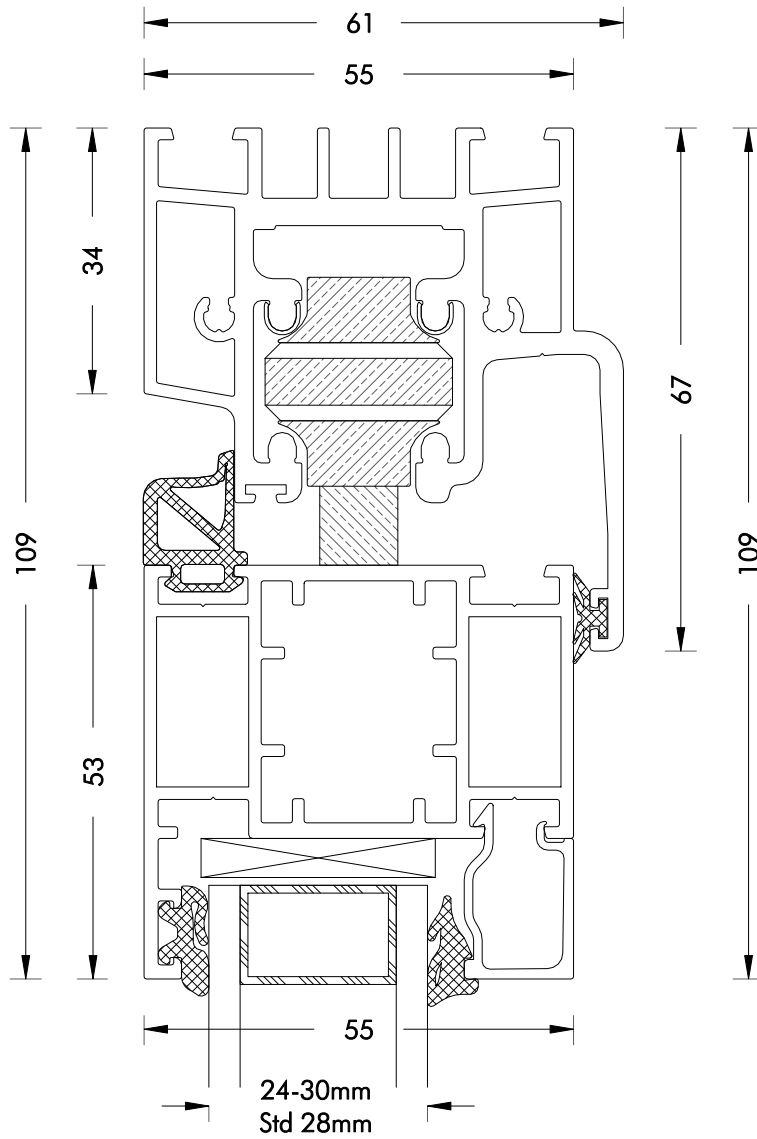

Description **Vertical Section - Connection**
Top Track - Panel / Open Out

Detail No: **SF50-02**

System: **SF50**

A

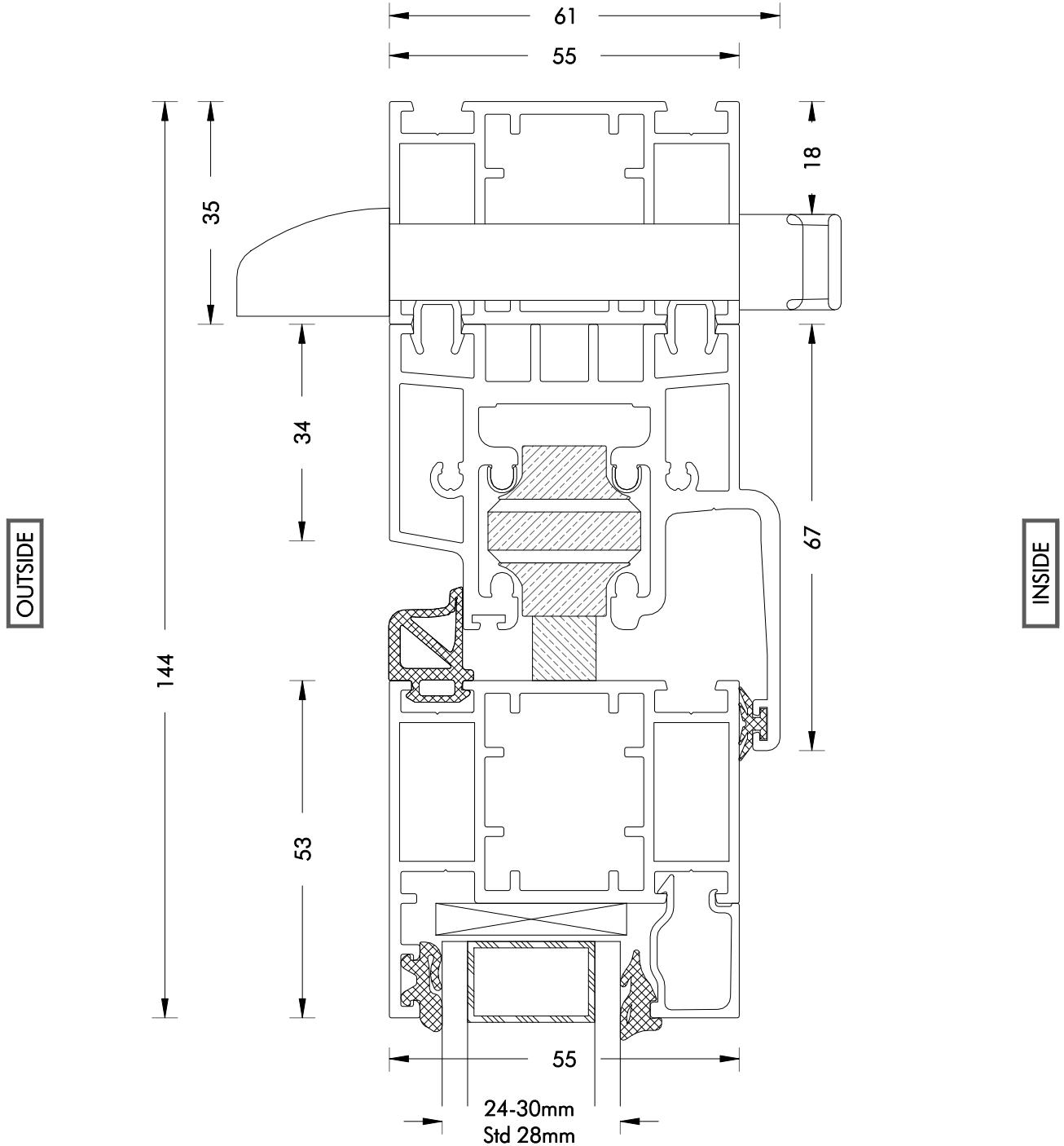
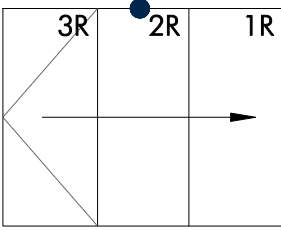

Description **Vertical Section - Connection**
Top Track With 35mm Extension And Trickle Vent - Panel /
Open Out

Detail No: **SF50-02TV**

System: **SF50**

A

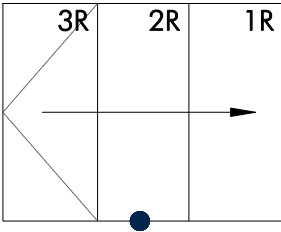

OUTSIDE

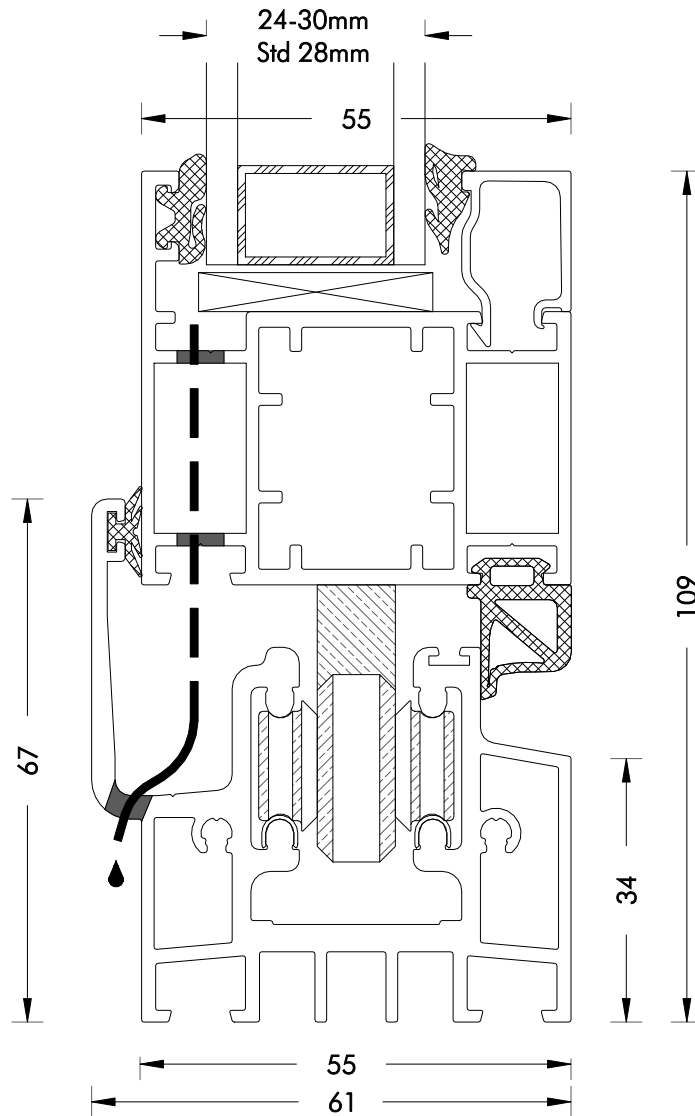

INSIDE

Description **Vertical Section - Connection**
Panel - Bottom Weathered Track / Open In

Detail No: **SF50-03**

System: **SF50**

A

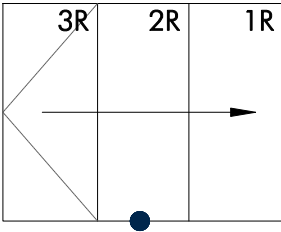

OUTSIDE

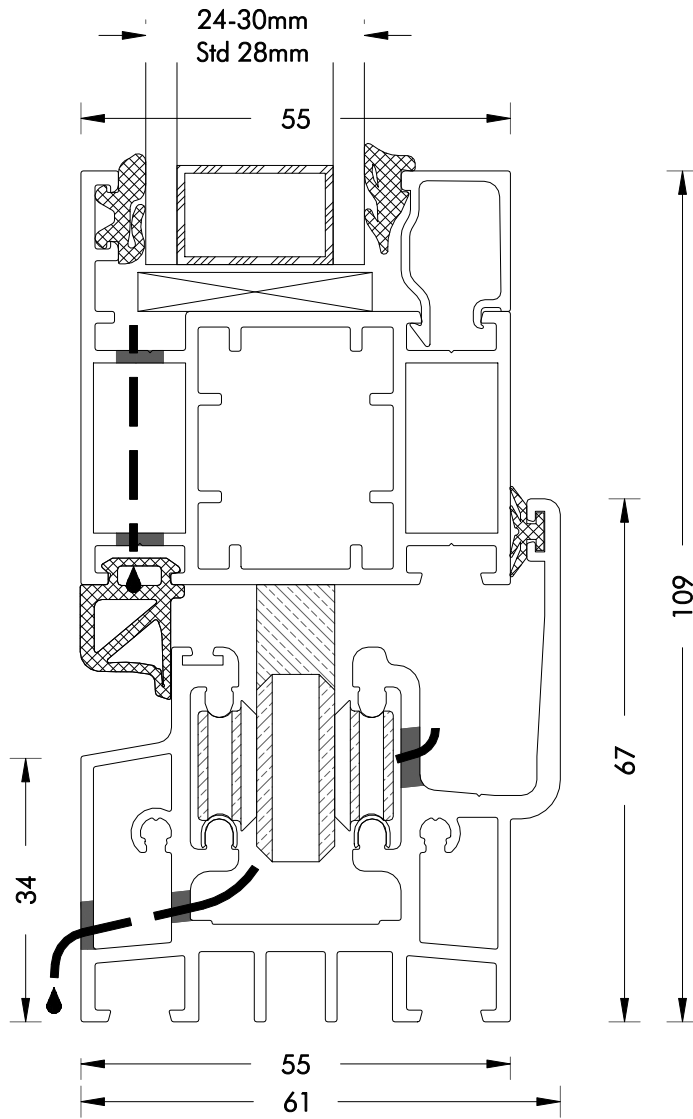

INSIDE

Description **Vertical Section - Connection**
Panel - Bottom Weathered Track / Open Out

Detail No: **SF50-04**

System: **SF50**

A

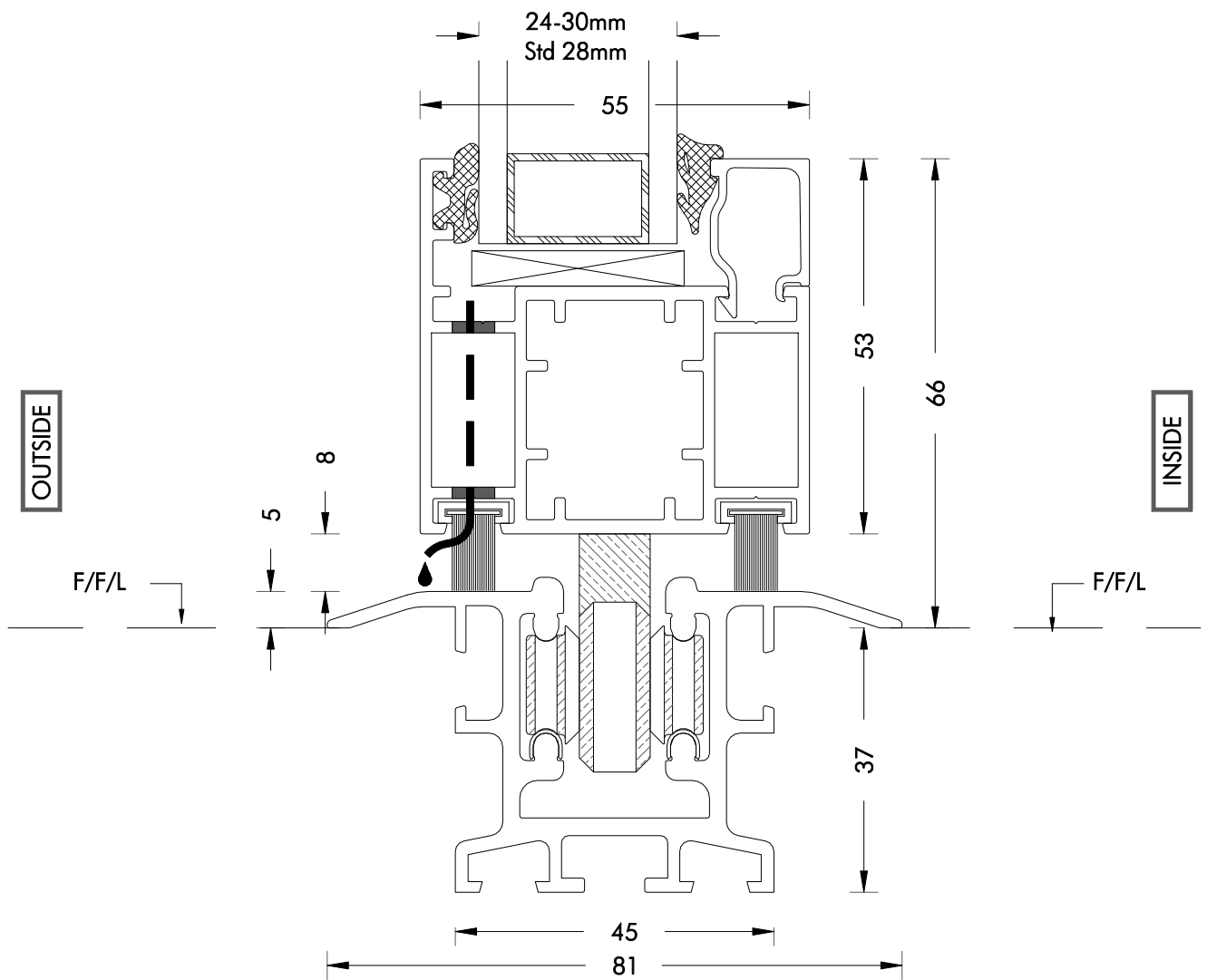
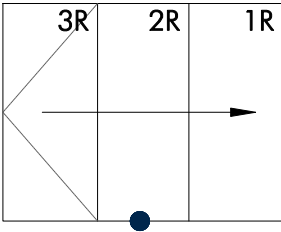

**Note: Flush Track Reduces Weather Rating
Not Recommended for Exposed Locations
On External Flush Track Systems We Recommend External Floor Level (Unless Decking),
is Laid with a Fall Away from the Track to Prevent Water Ingress**

Description **Vertical Section - Connection
Panel - Bottom Flush Track**

Detail No: **SF50-05**

System: **SF50**

A

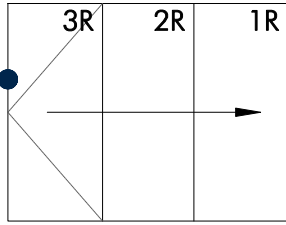

OUTSIDE

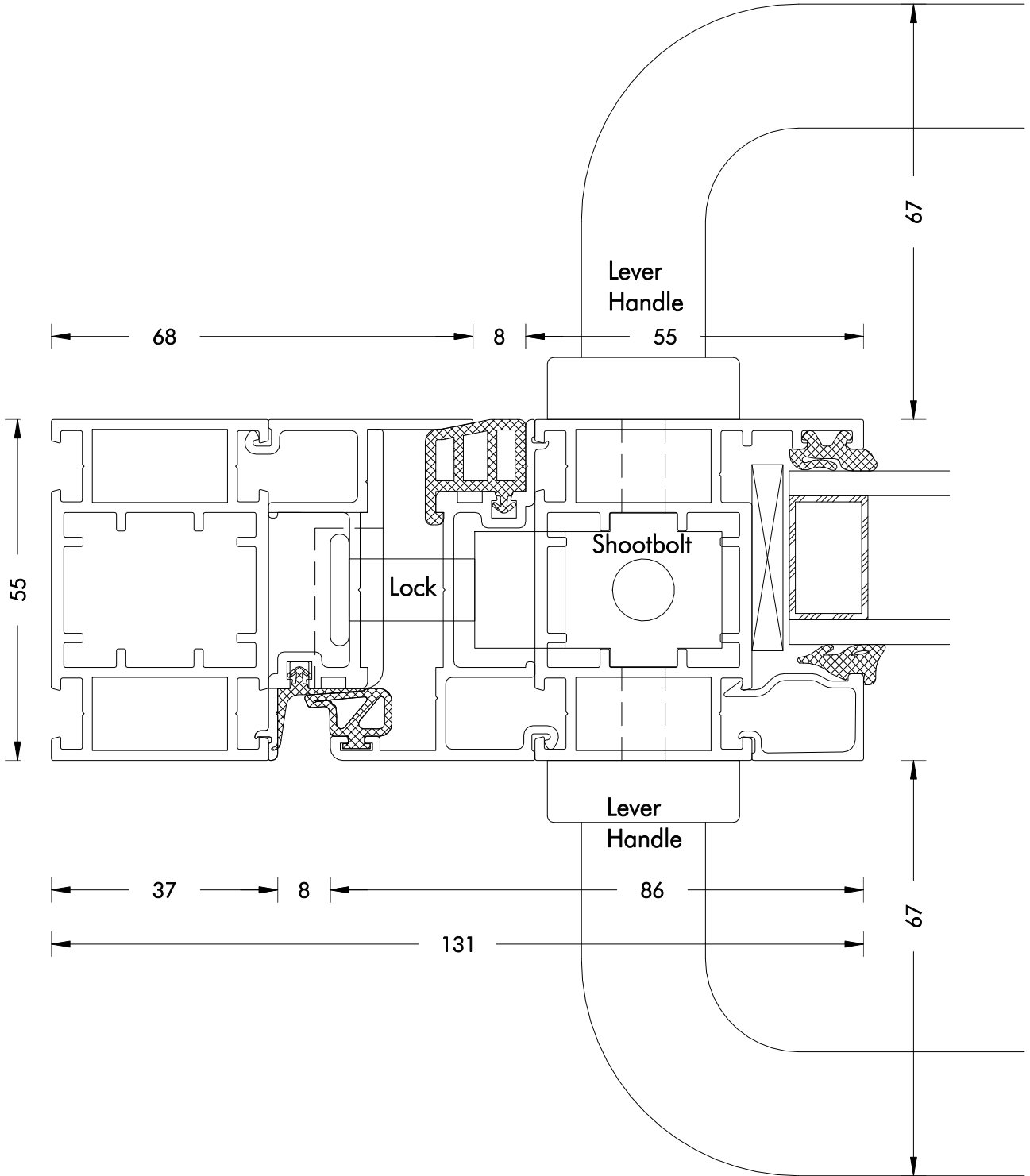

INSIDE

Description **Horizontal Section - Connection**
Closing Jamb - Panel 3R / Open In

Detail No: **SF50-06**

System: **SF50**

A

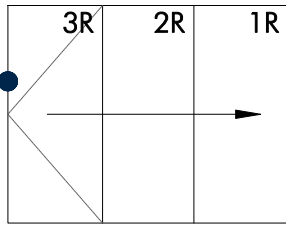

OUTSIDE

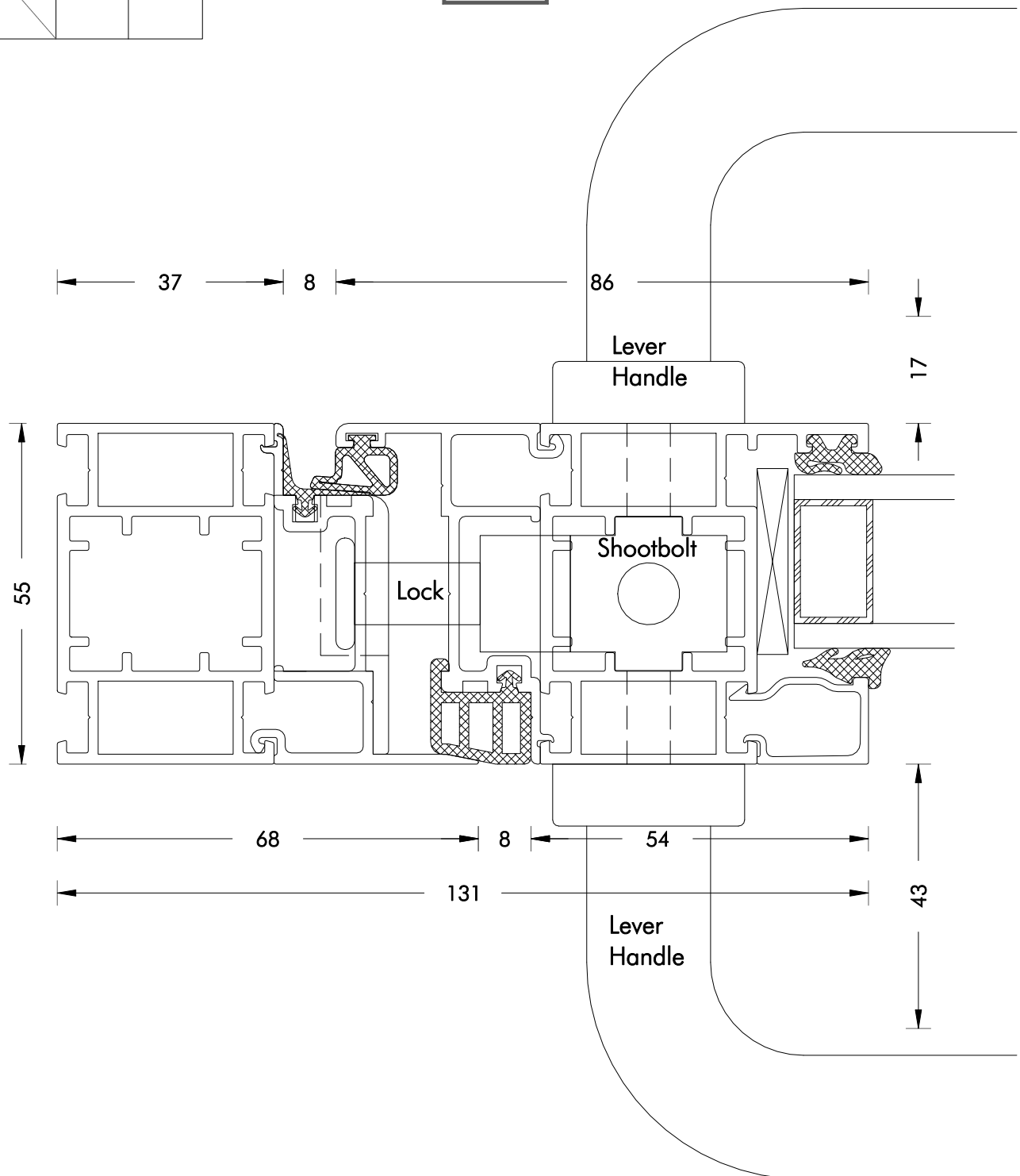

INSIDE

Description **Horizontal Section - Connection**
Closing Jamb - Panel 3R / Open Out

Detail No: **SF50-07**

System: **SF50**

A

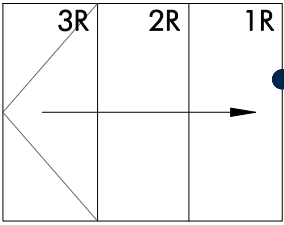

OUTSIDE

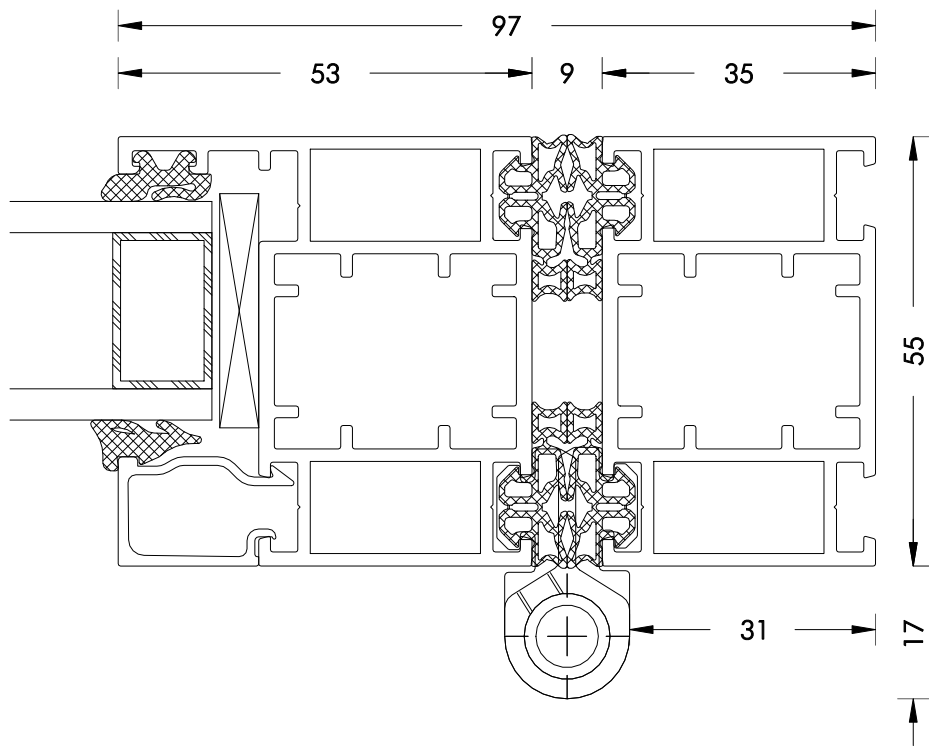

INSIDE

Description **Horizontal Section - Connection**
Panel 1R - Hinge Jamb / Open In

Detail No: **SF50-08**

System: **SF50**

A

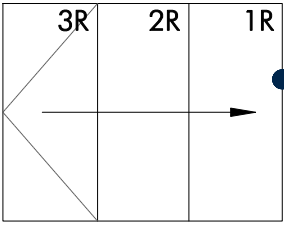

OUTSIDE

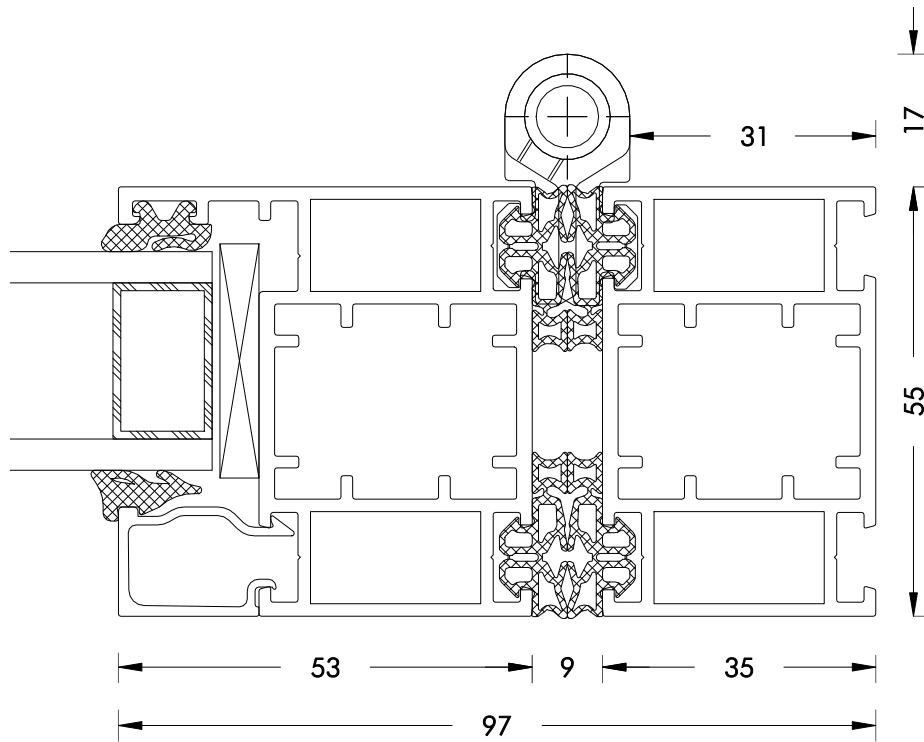

INSIDE

Description **Horizontal Section - Connection**
Panel 1R - Hinge Jamb / Open Out

Detail No: **SF50-09**

System: **SF50**

A

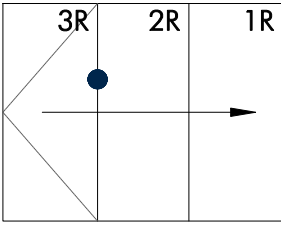

OUTSIDE

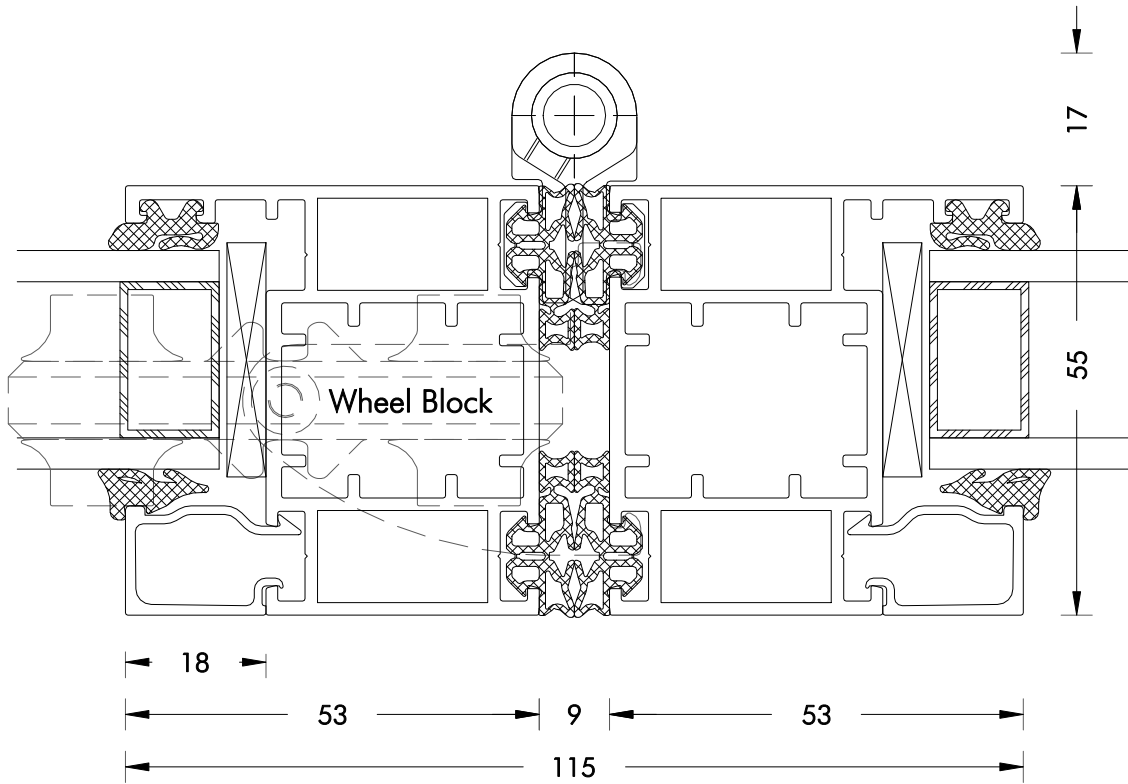

INSIDE

Description **Horizontal Section - Connection**
Panel 3R - Panel 2R / Open Out

Detail No: **SF50-10**

System: **SF50**

A

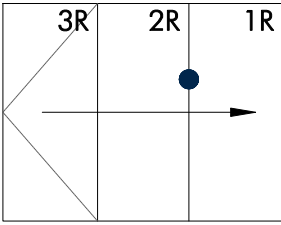

OUTSIDE

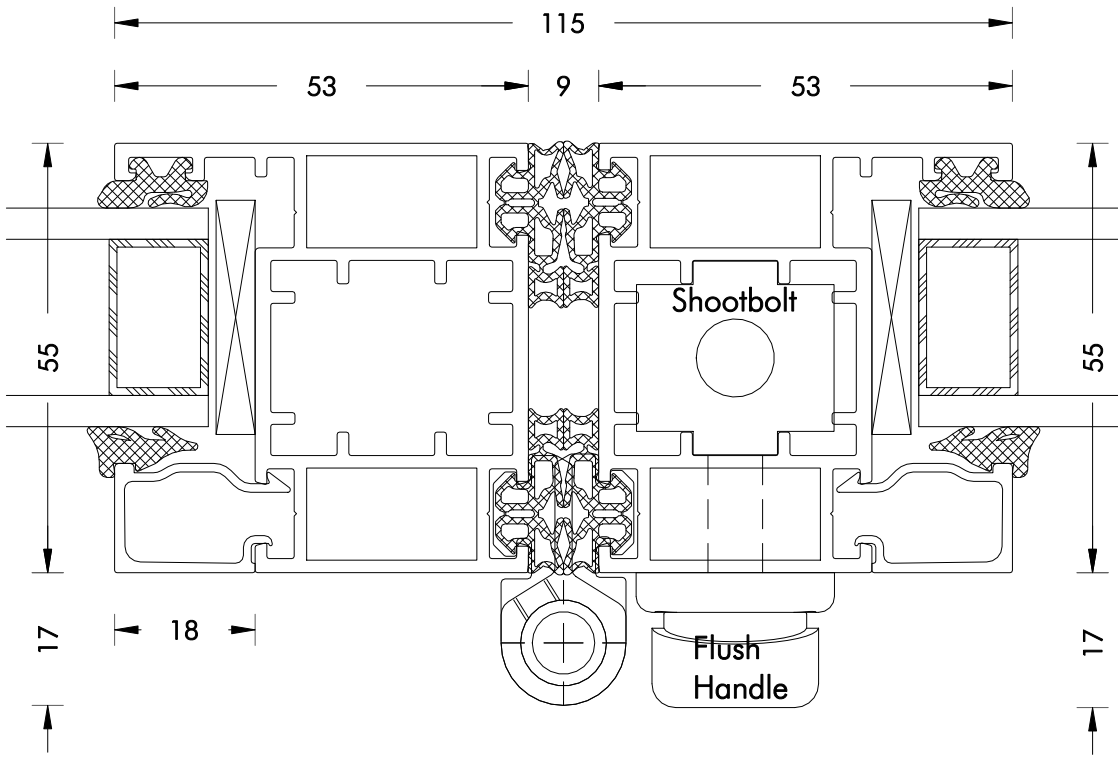

INSIDE

Description **Horizontal Section - Connection
Panel 2R - Panel 1R / Open Out**

Detail No: **SF50-11**

System: **SF50**

A

OUTSIDE

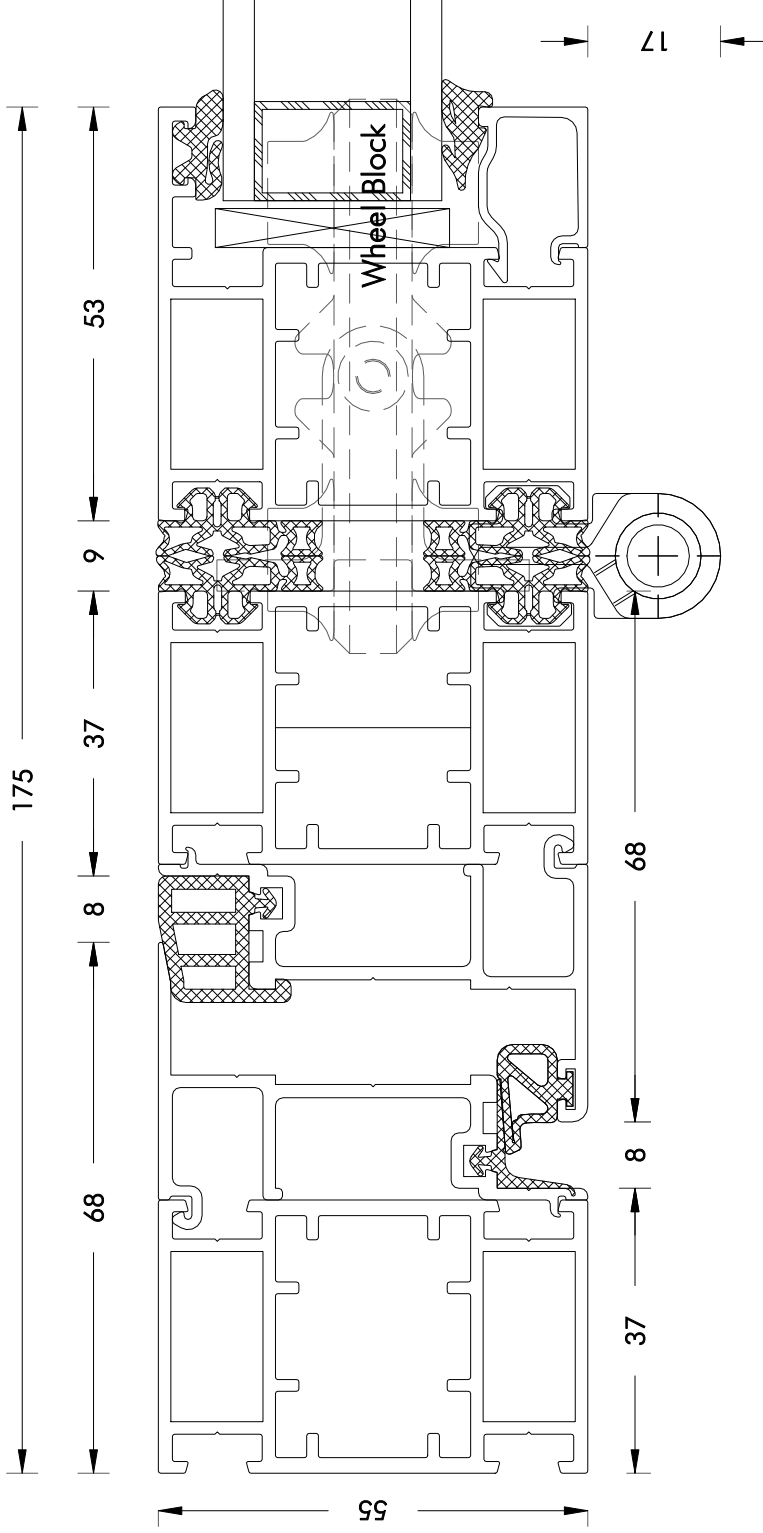
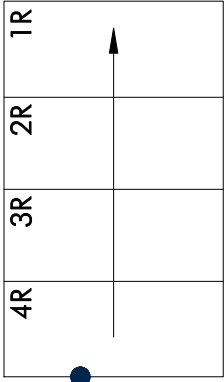

INSIDE

Description **Horizontal Section - Connection
Closing Jamb - Sliding Post - Panel 4R / Open In**

Detail No: **SF50-12**

System: **SF50** **A**

OUTSIDE

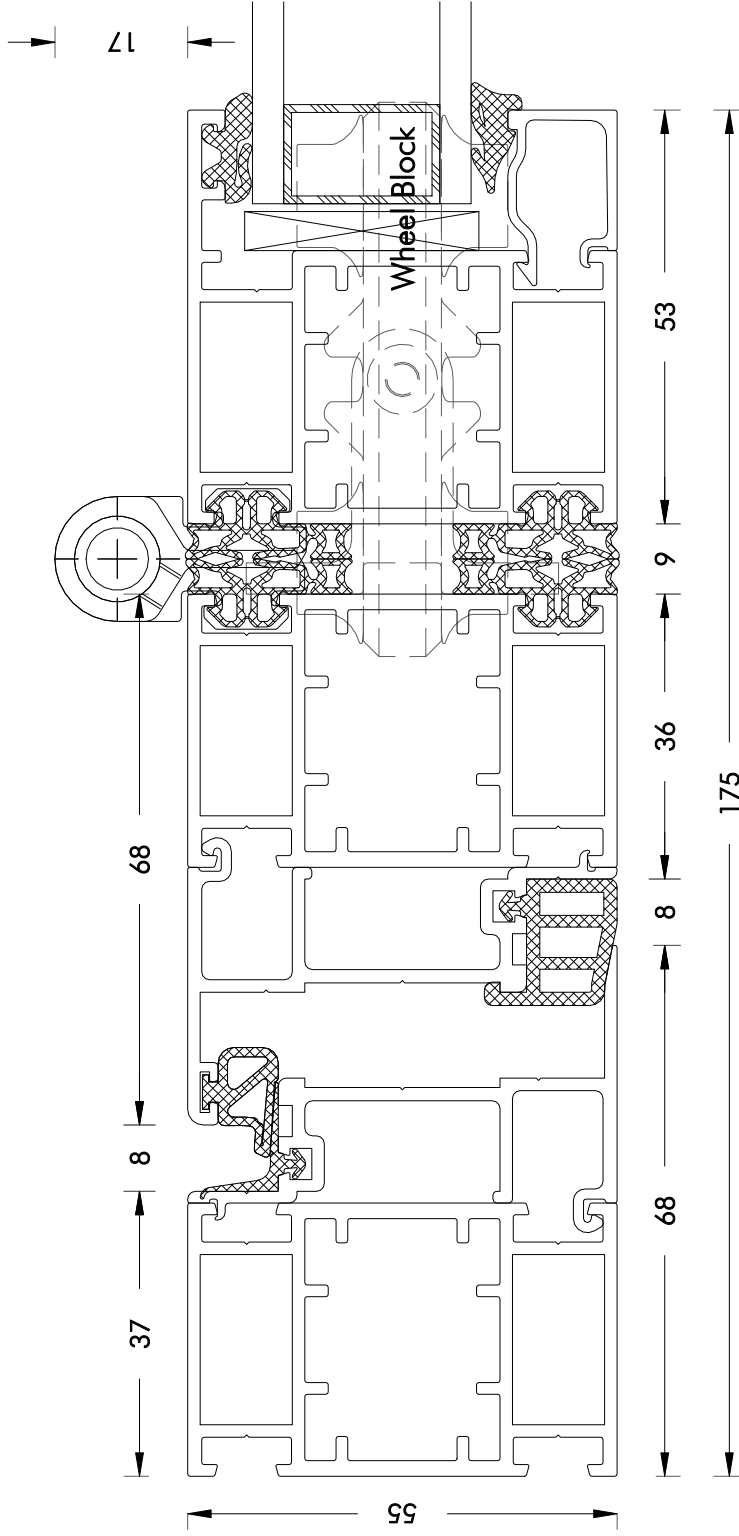
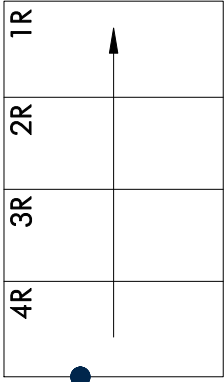

Description **Horizontal Section - Connection Closing Jamb - Sliding Post - Panel 4R / Open Out**

Detail No: **SF50-13**

System: **SF50** **A**

OUTSIDE

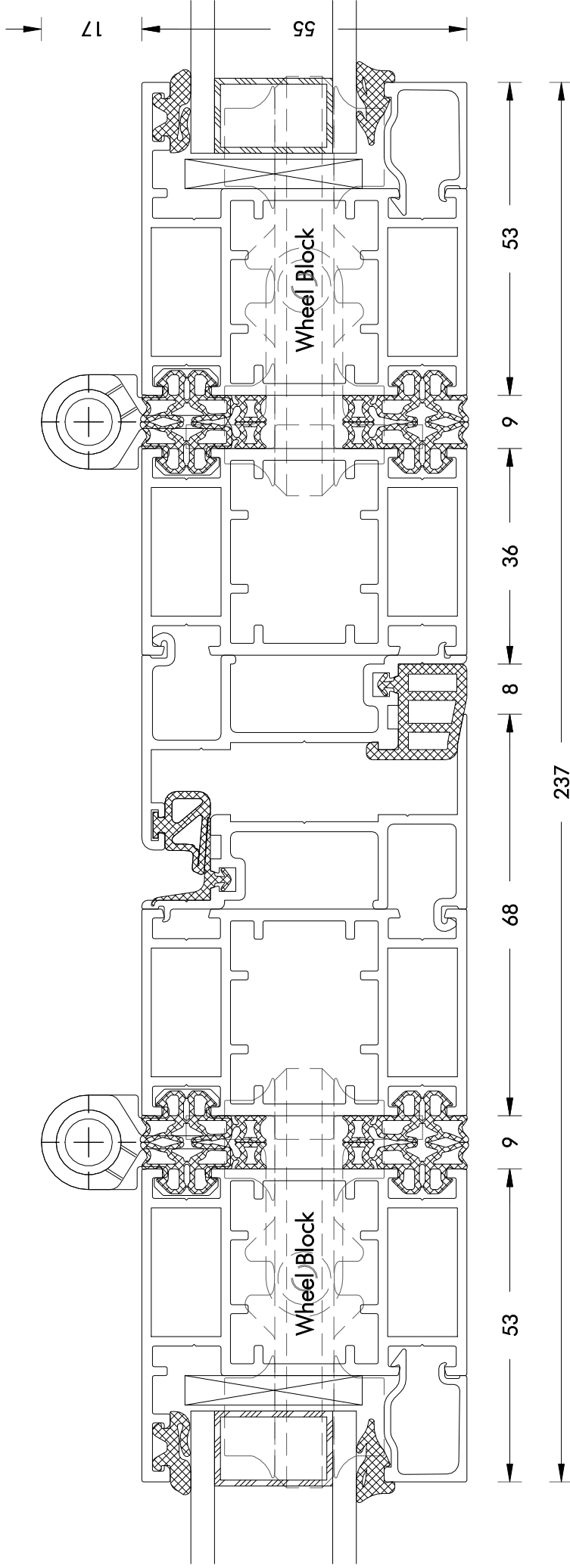
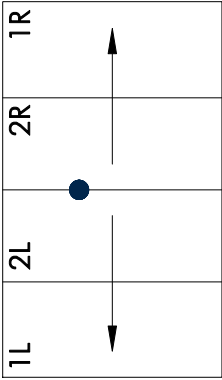

INSIDE

Description **Horizontal Section - Connection
Panel 2L - Sliding Post - Sliding Post - Panel 2R / Open Out**

Detail No: **SF50-14**

System: **SF50**

A

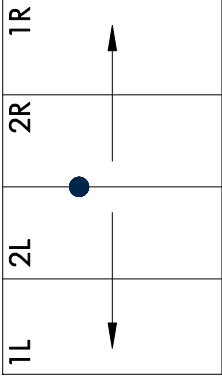

OUTSIDE

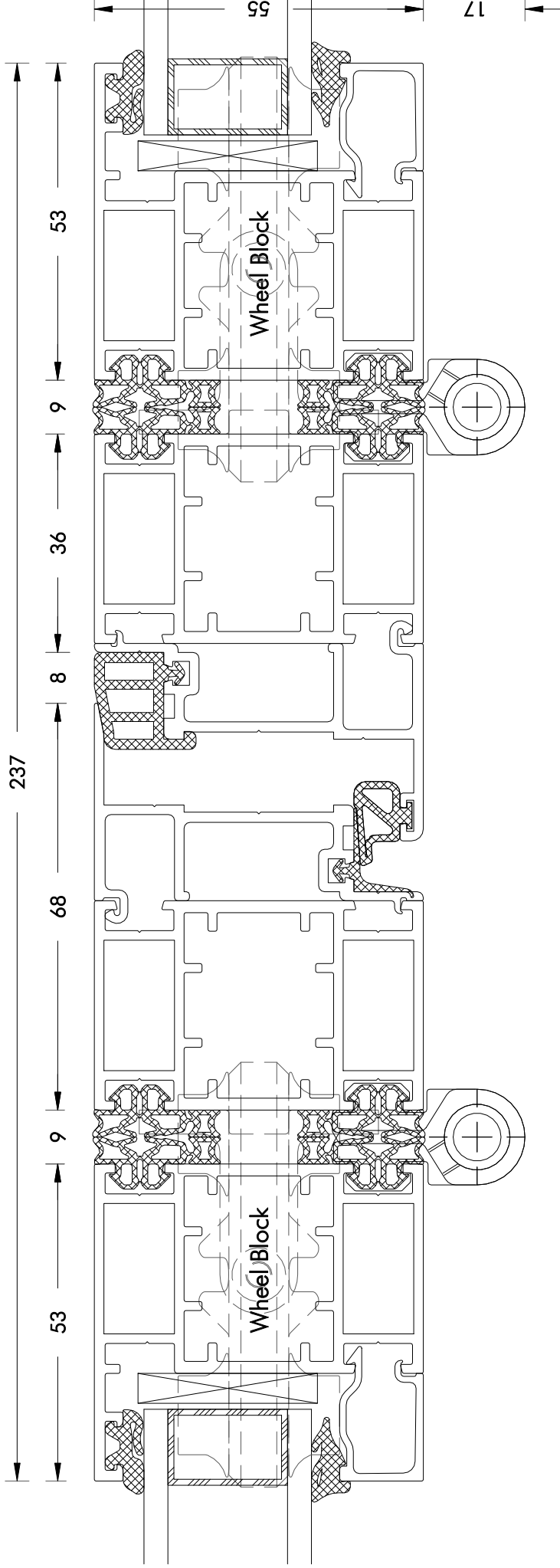

INSIDE

Description **Horizontal Section - Connection
Panel 2L - Sliding Post - Sliding Post - Panel 2R / Open In**

Detail No: **SF50-15**

System: **SF50**

A

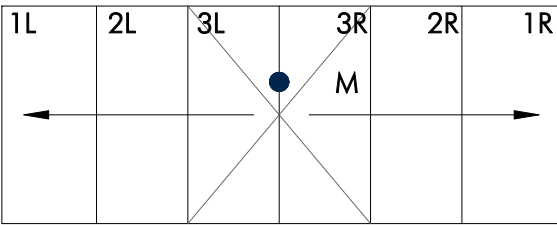

OUTSIDE

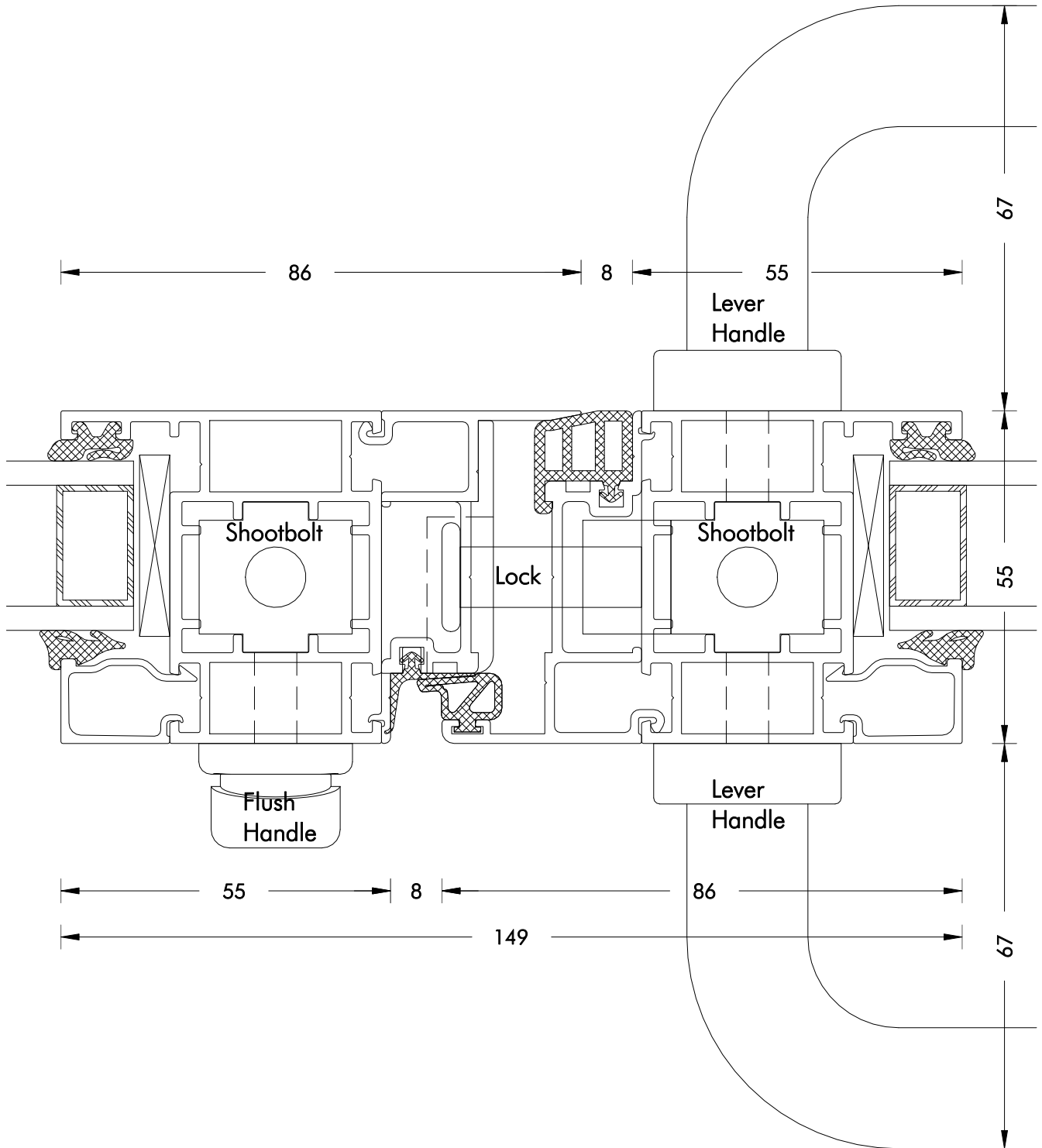

INSIDE

Description **Horizontal Section - Connection
Panel 3L - Panel 3R / Open In
(M = 1st Opening Panel 3R)**

Detail No: **SF50-16**

System: **SF50**

A



IDSystems
GLASS INNOVATIONS

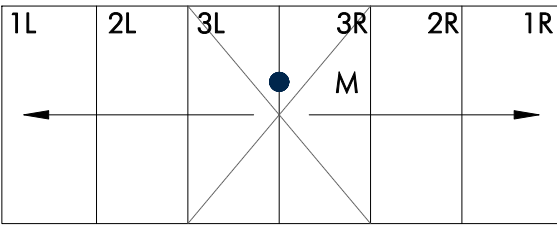

OUTSIDE

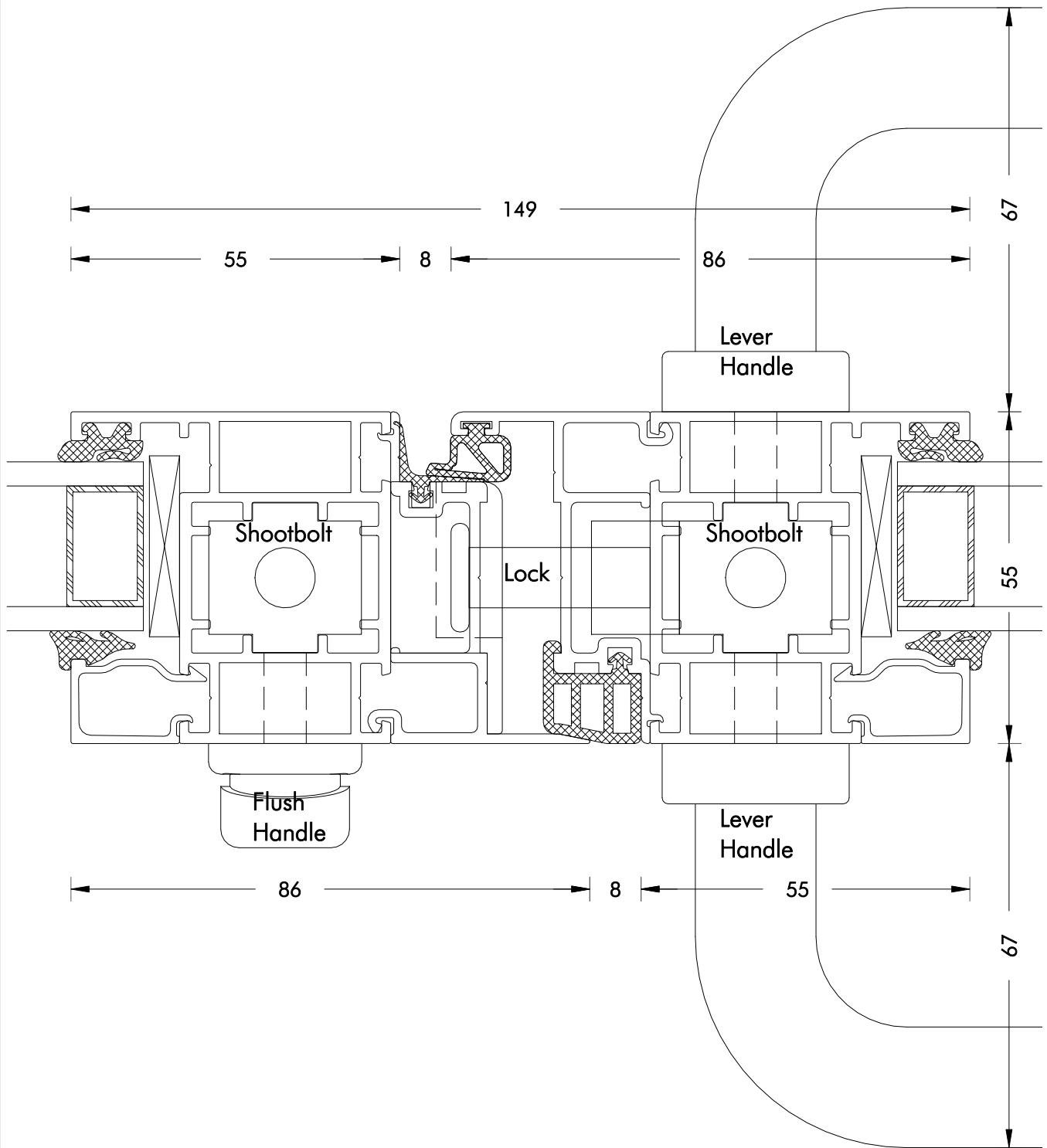

INSIDE

Description **Horizontal Section - Connection
Panel 3L - Panel 3R / Open Out
(M = 1st Opening Panel 3R)**

Detail No: **SF50-17**

System: **SF50**

A

OUTSIDE

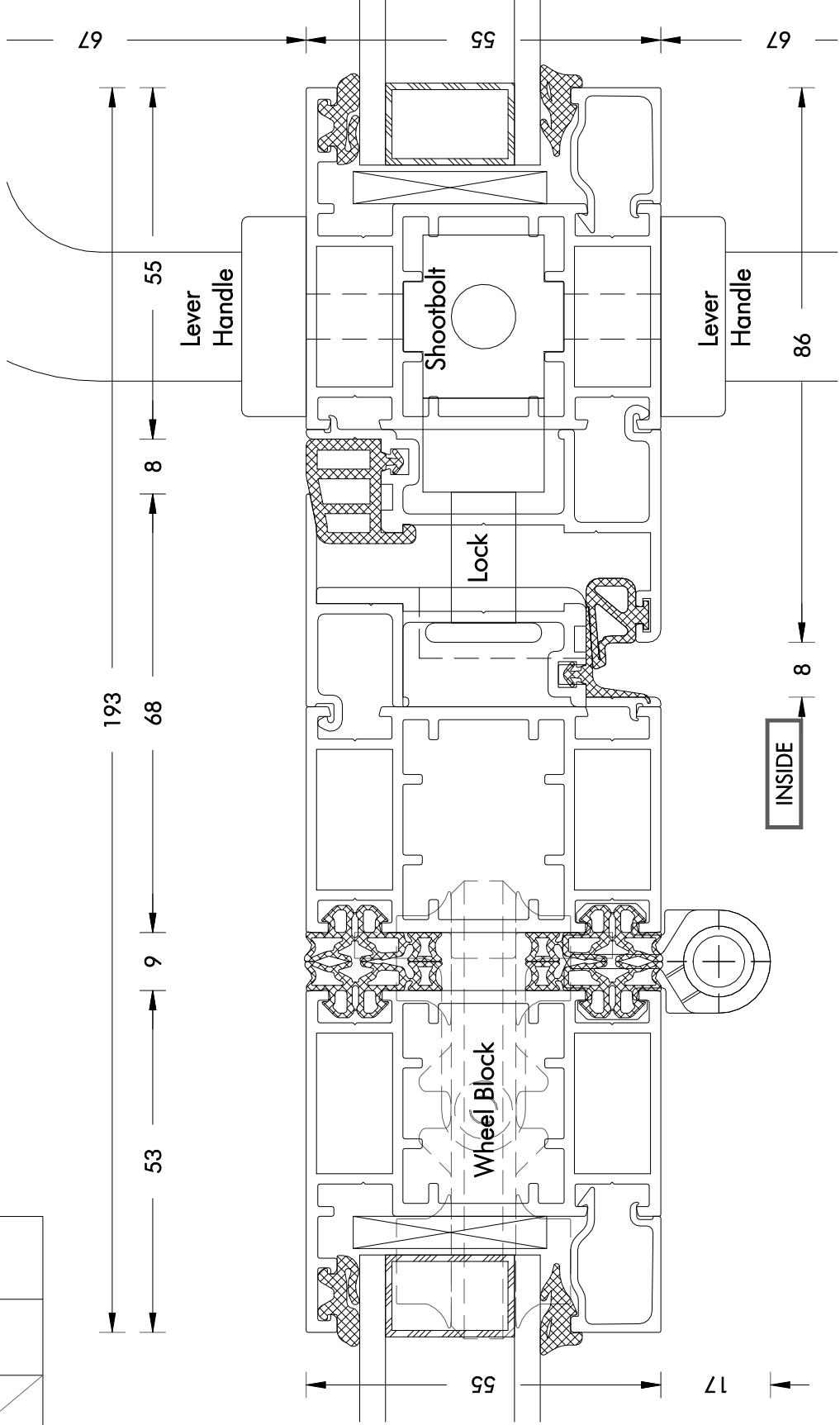
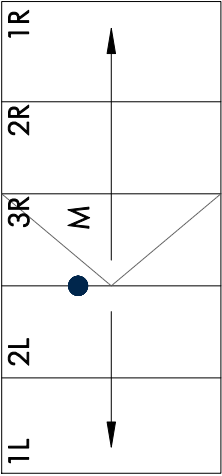

Description **Horizontal Section - Connection**
Panel 2L - Sliding Post - Panel 3R / Open In
(M = 1st Opening Panel 3R)

Detail No: **SF50-18**

System: **SF50**

A

OUTSIDE

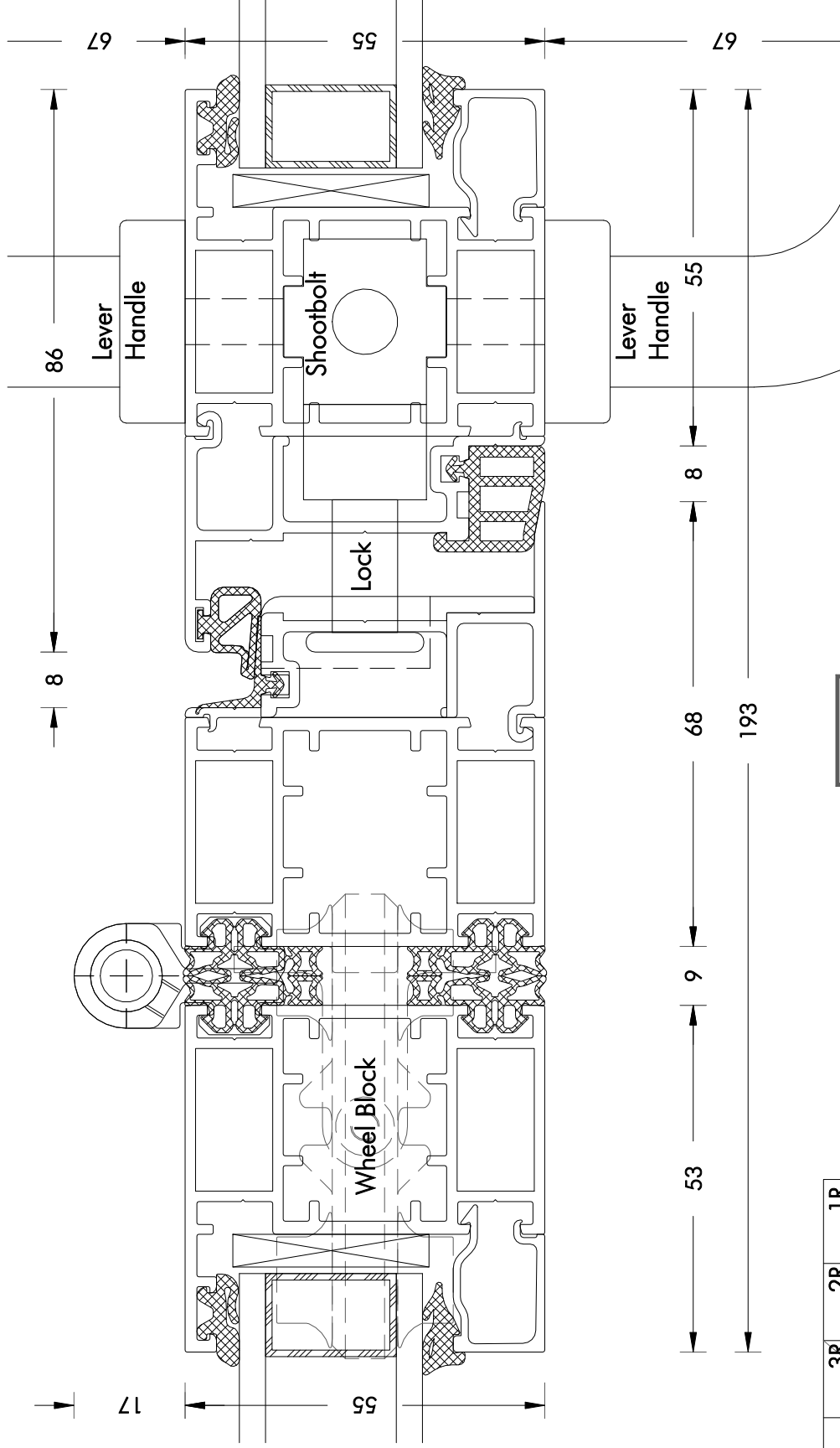

INSIDE

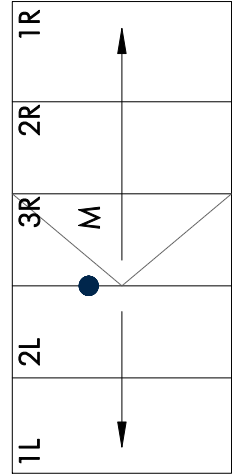

Description **Horizontal Section - Connection**
Panel 2L - Sliding Post - Panel 3R / Open Out
(M = 1st Opening Panel 3R)

Detail No: **SF50-19**

System: **SF50** **A**

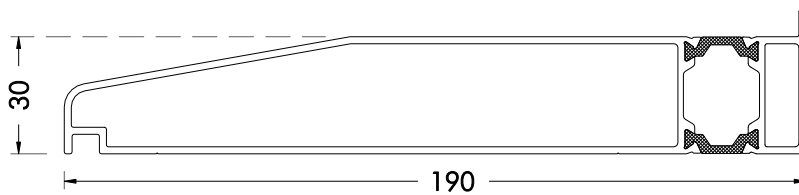
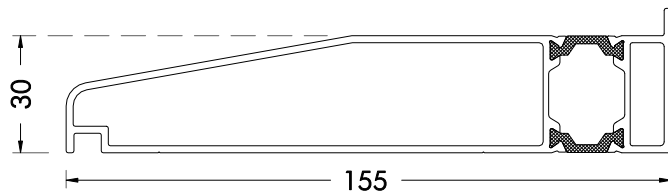
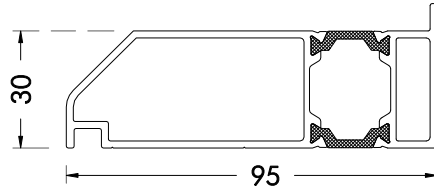

Description **Thermally Broken Aluminium Sills - Size Options**

Detail No: **SF50-20**

System: **SF50**

A

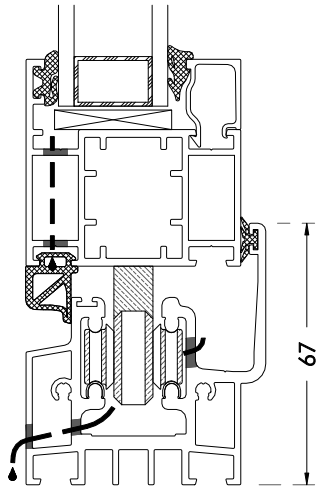

Option 1, Open Out Weathered track

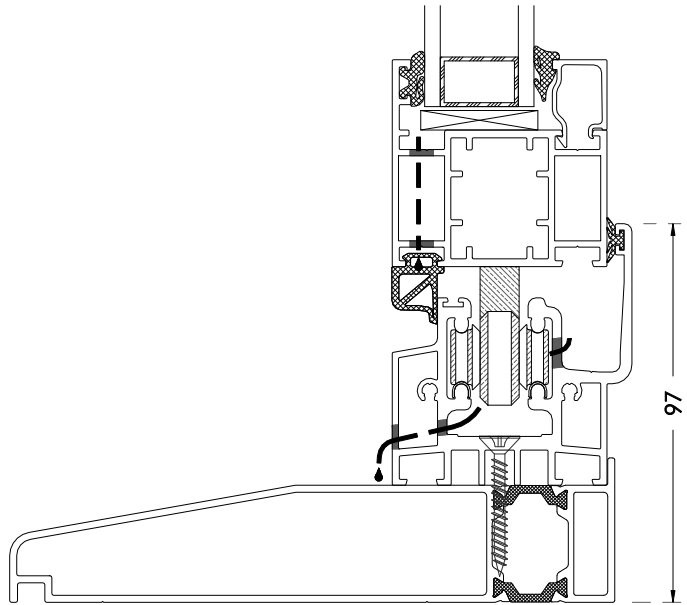

Option 3, Open Out Weathered track on 155mm Thermally Broken Sill

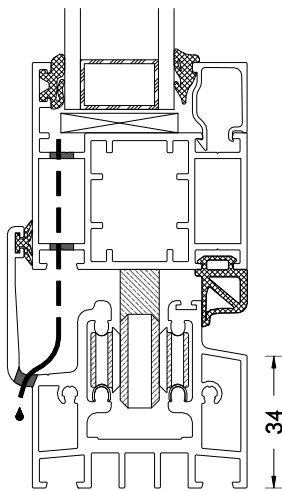

Option 2, Open In Weathered track

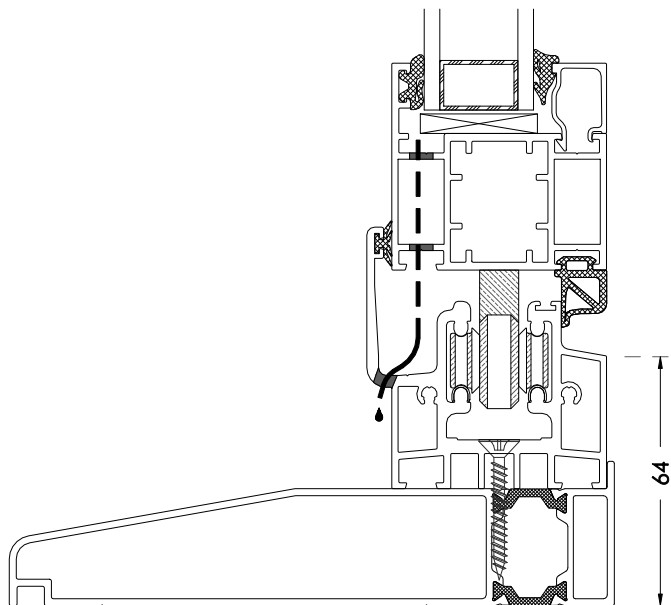

Option 4, Open In Weathered track on 155mm Thermally Broken Sill

Description **Vertical Section
Threshold Options - Weathered Track**

Detail No: **SF50-21**

System: **SF50**

A

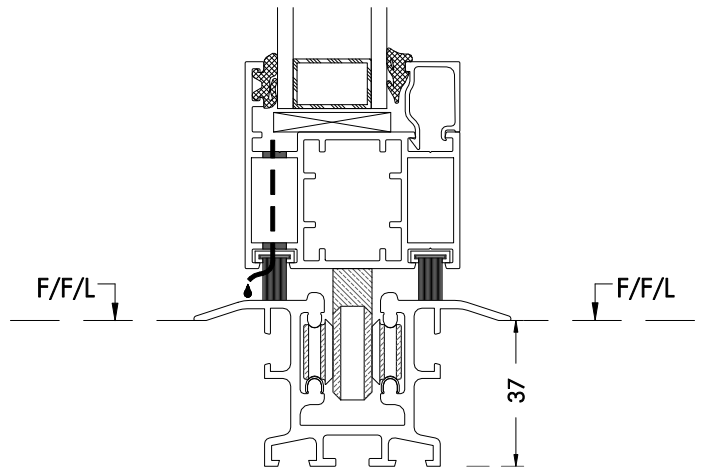

Option 5, Flush track

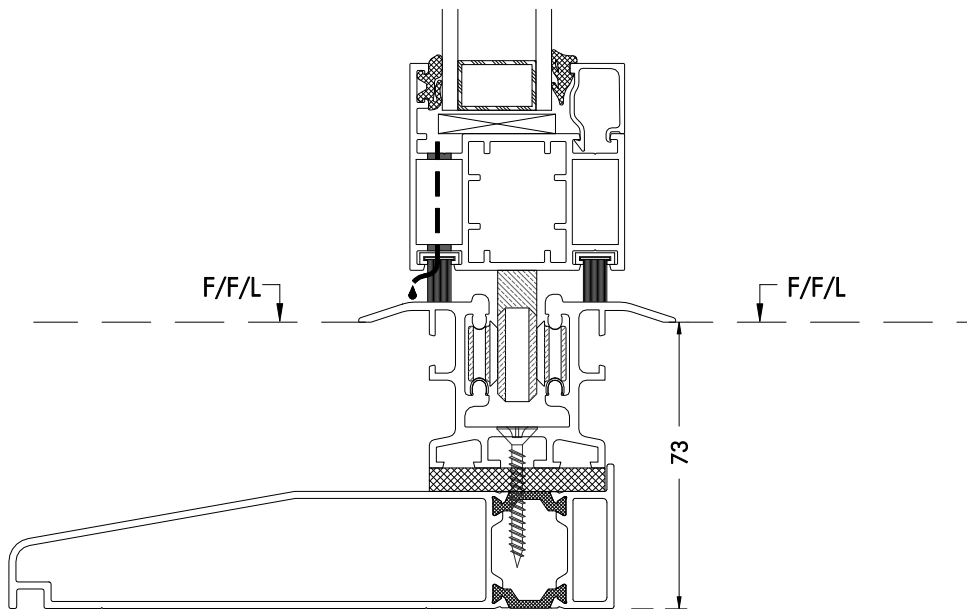

**Option 6, Flush track on
155mm Thermally Broken Sill**

**Note: Flush Track Reduces Weather Rating
Not Recommended for Exposed Locations**

Description **Vertical Section
Threshold Options - Flush Track**

Detail No: **SF50-22**

System: **SF50**

A

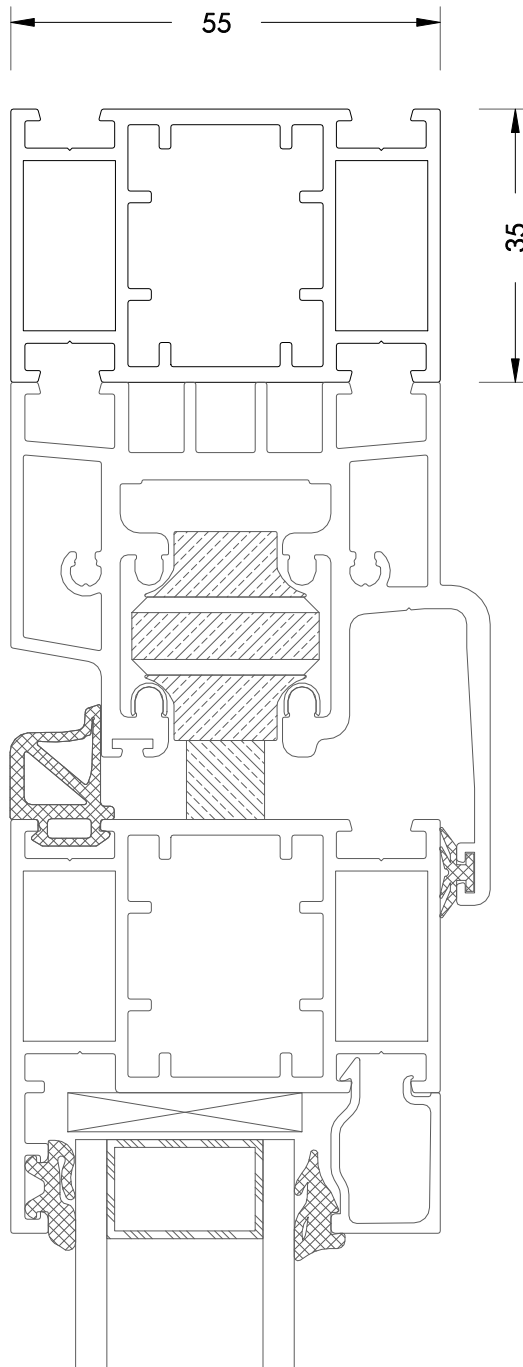

35mm Add-on

Description **Horizontal Section
Additional Profiles**

Detail No: **SF50-23**

System: **SF50**

A

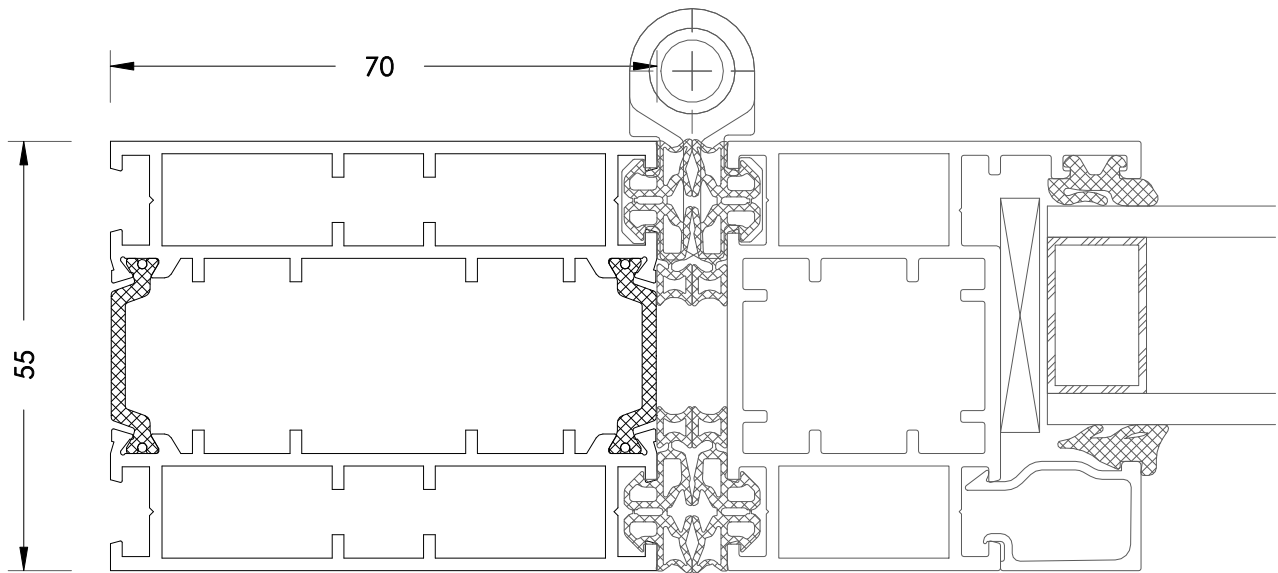

70mm Jamb

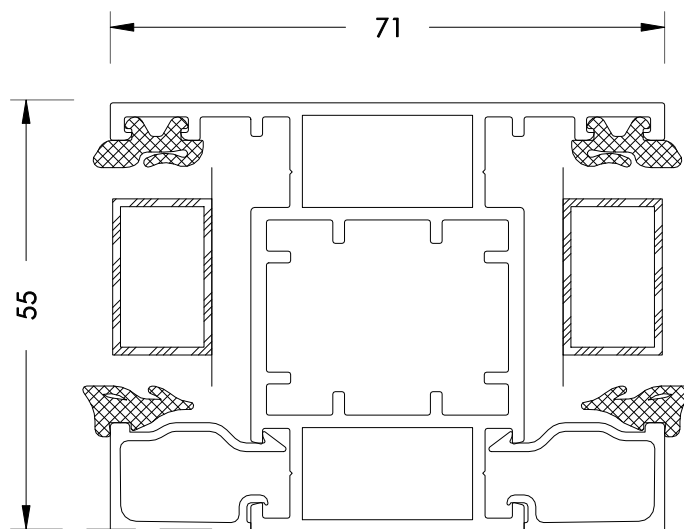

Transom / Mullion

Description **Horizontal Section**
Additional Profiles

Detail No: **SF50-24**

System: **SF50**

A

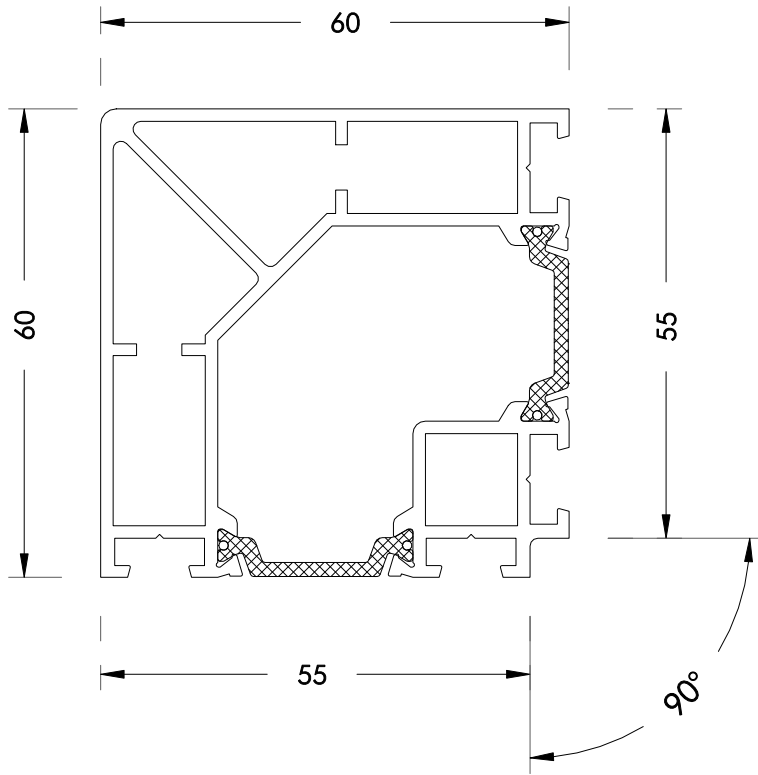

90° Post

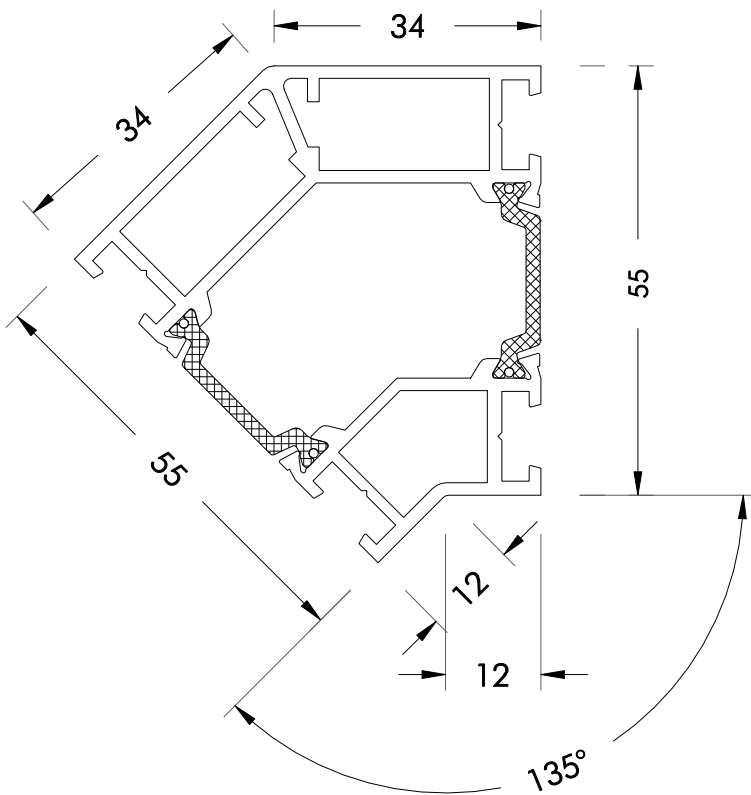

135° Post

Description **Horizontal Section**
Vertical Post Options

Detail No: **SF50-25**

System: **SF50**

A

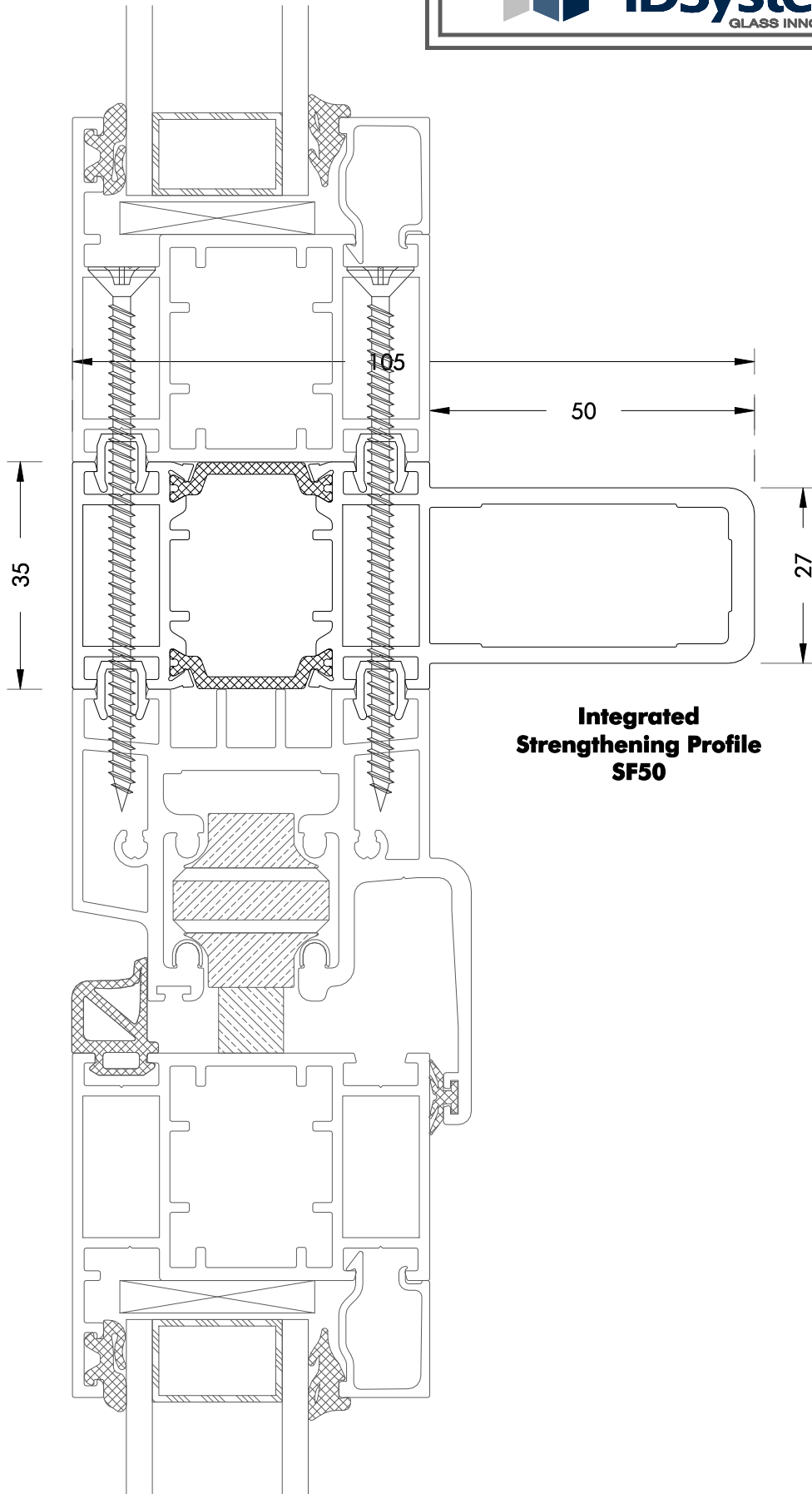

NB:-

Required to be used on Door sets with Overlights when System Width Exceeds 3 M * in Exposed Locations or when System Width Exceeds 4 M * in Unexposed Locations

*** This dimension may vary according to the depth of the Overlights**

Description **Vertical Section
Overlight - Strengthening Profile - Top Track**

Detail No: **SF50-26**

System: **SF50**

A

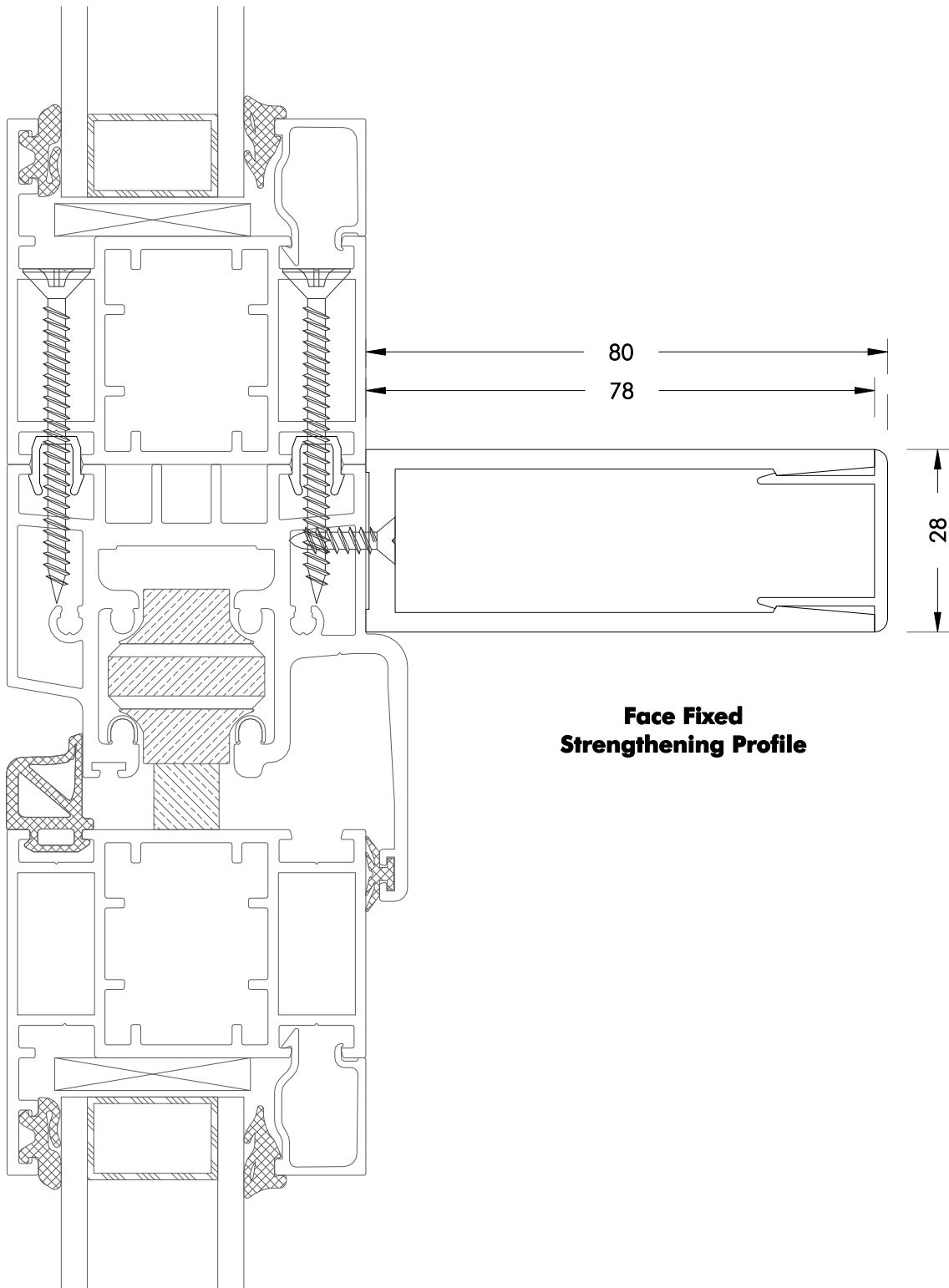

**Face Fixed
Strengthening Profile**

NB:-

Required to be used on Door sets with Overlights In Unexposed Locations when System Width Exceeds 2.5, upto a Maximum of 4 M *

*** This dimension may vary according to the depth of the Overlights**

Description **Vertical Section
Overlight - Top Track with Additional Face Fixed
Strengthening Profile**

Detail No: **SF50-27**

System: **SF50**

A



**Fixed 90° Post with
Open Out Panels**

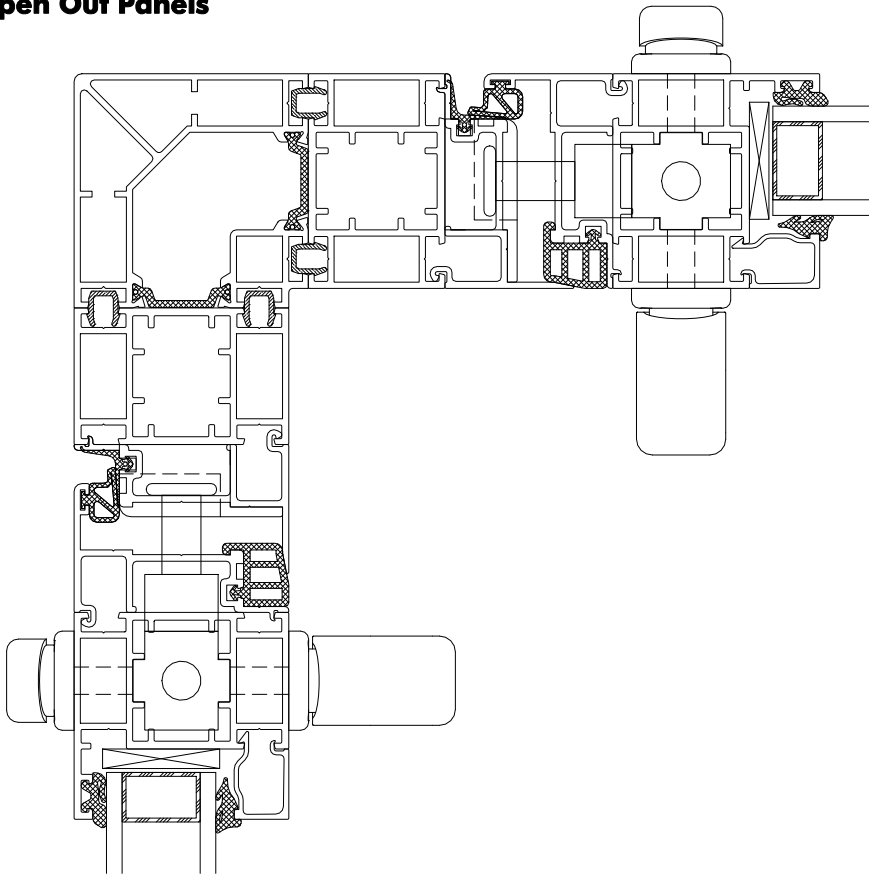

**Fixed 90° Post with
Open In Panels**

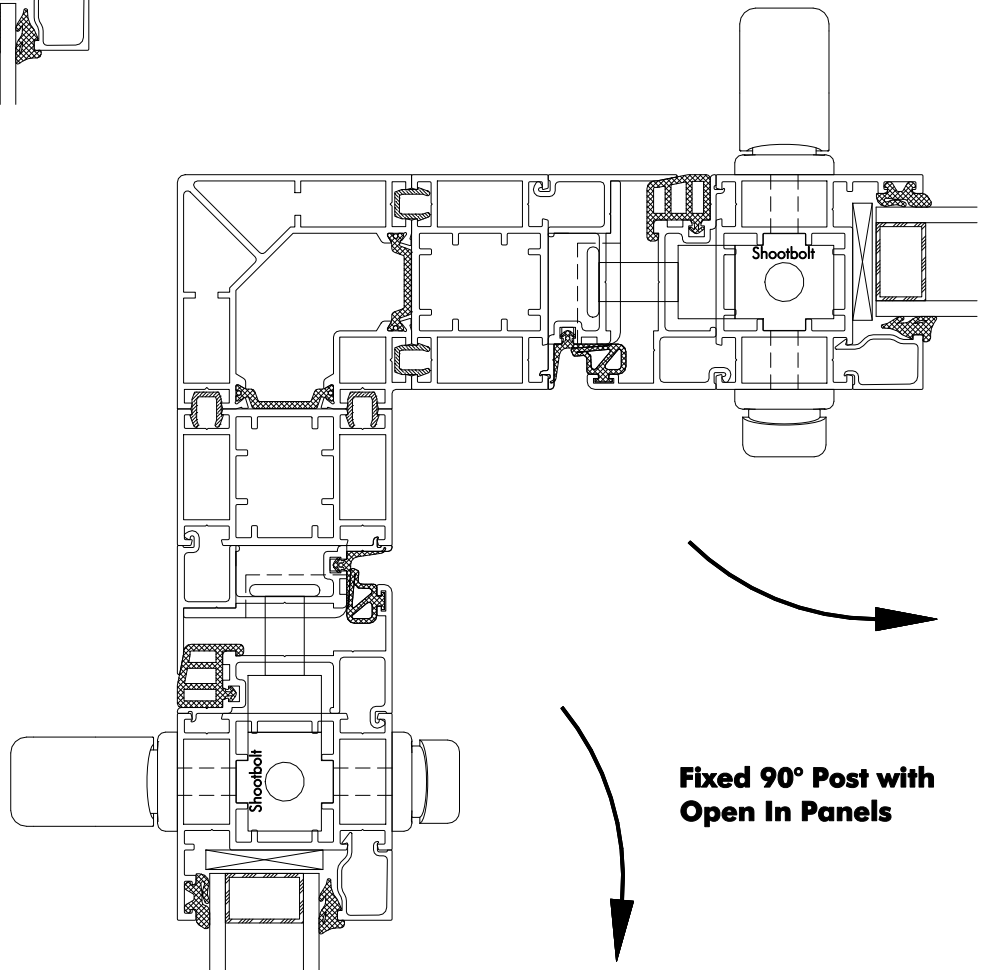

Description **Horizontal Section**
Typical Fixed 90° Post Examples

Detail No: **SF50-28**

System: **SF50**

A

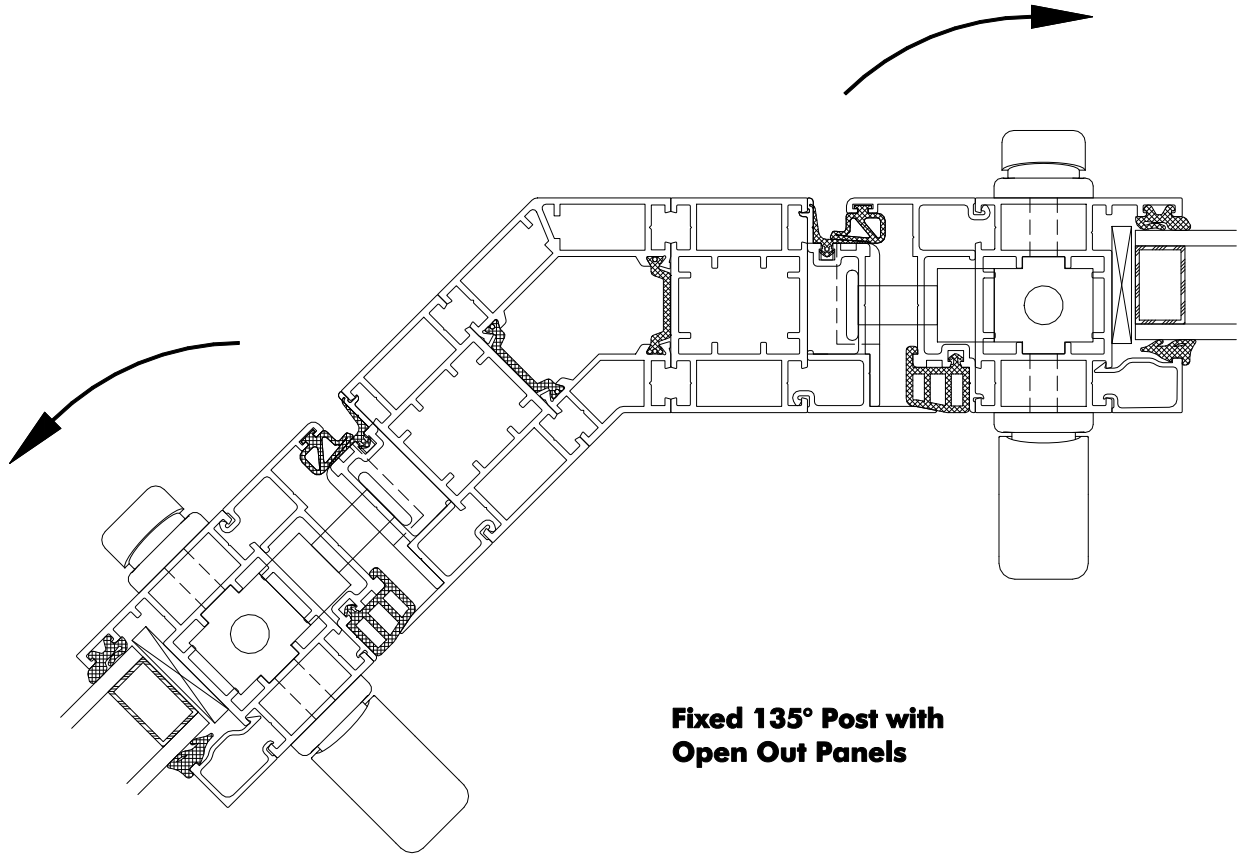

**Fixed 135° Post with
Open Out Panels**

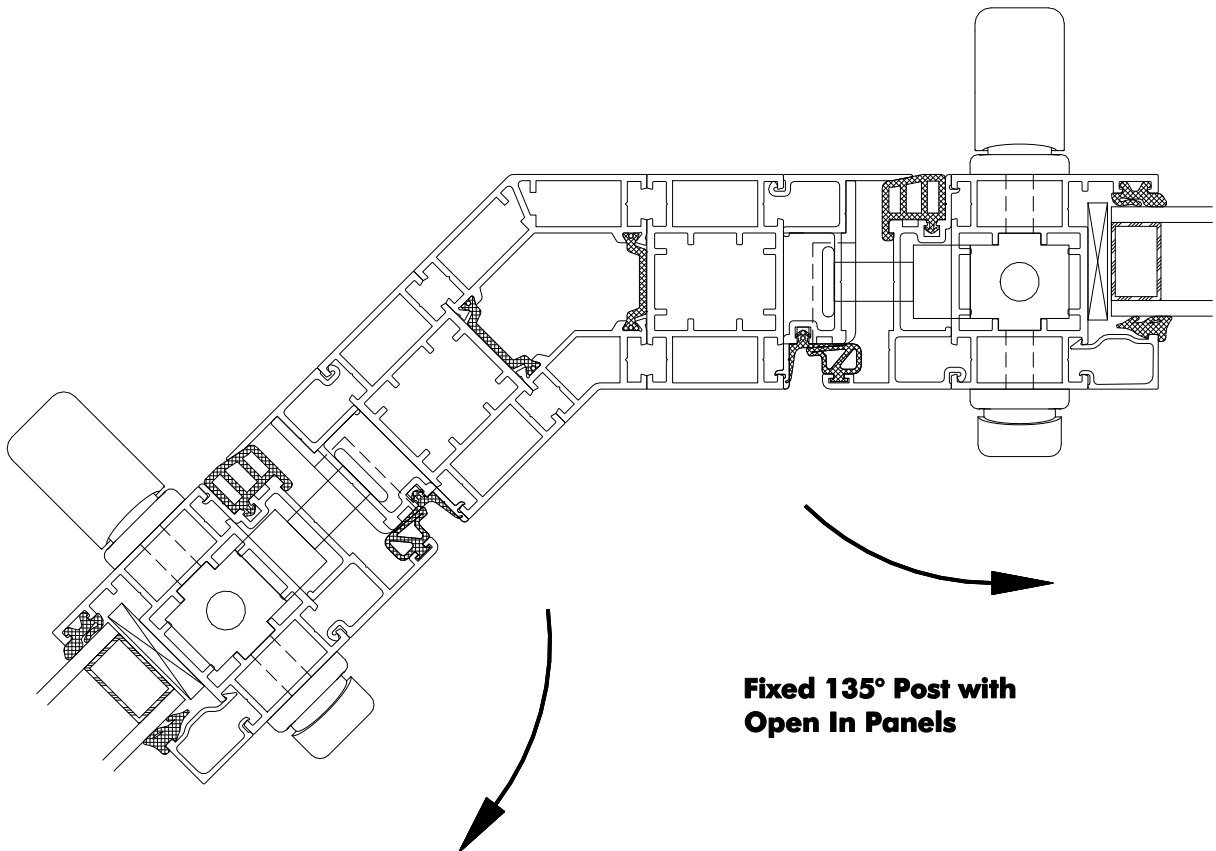

**Fixed 135° Post with
Open In Panels**

Description **Horizontal Section**
Typical Fixed 135° Post Examples

Detail No: **SF50-29**

System: **SF50**

A

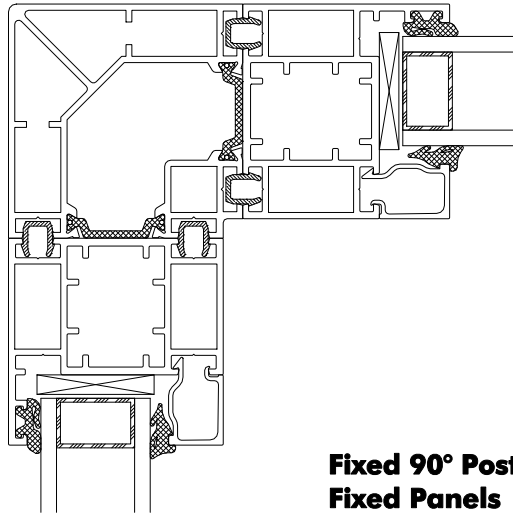

**Fixed 90° Post with
Fixed Panels**

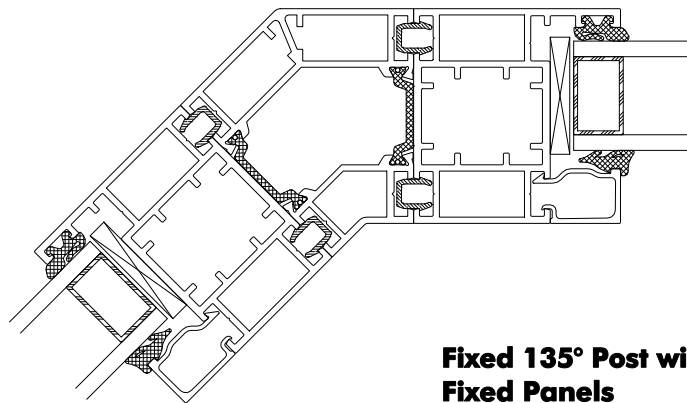

**Fixed 135° Post with
Fixed Panels**

Description **Horizontal Section
Typical Fixed Post Examples**

Detail No: **SF50-30**

System: **SF50**

A

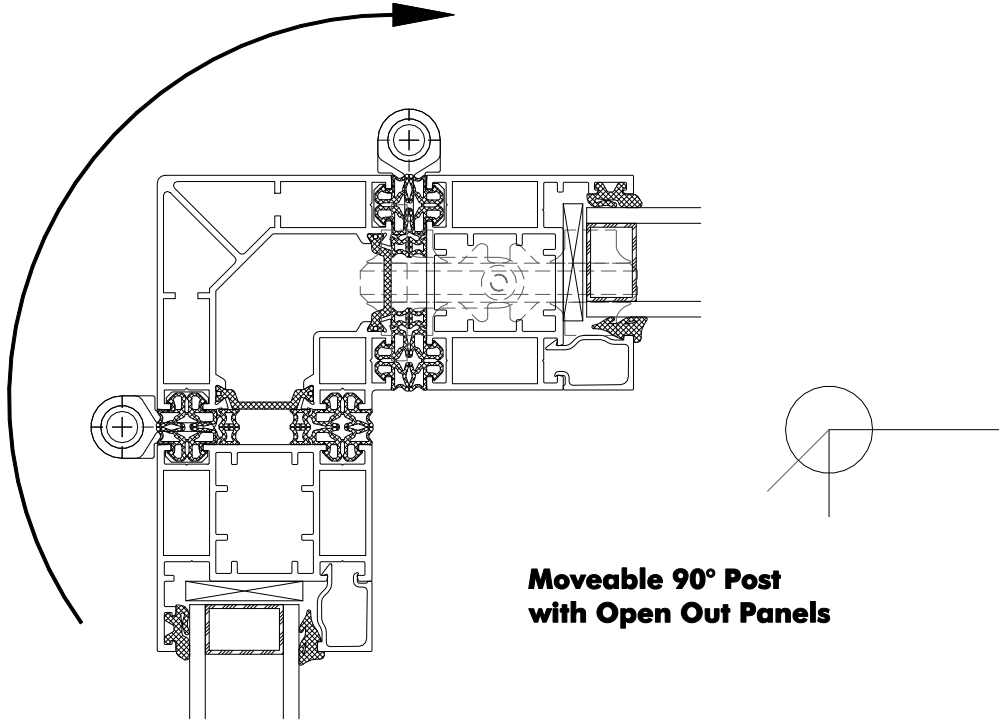

**Moveable 90° Post
with Open Out Panels**

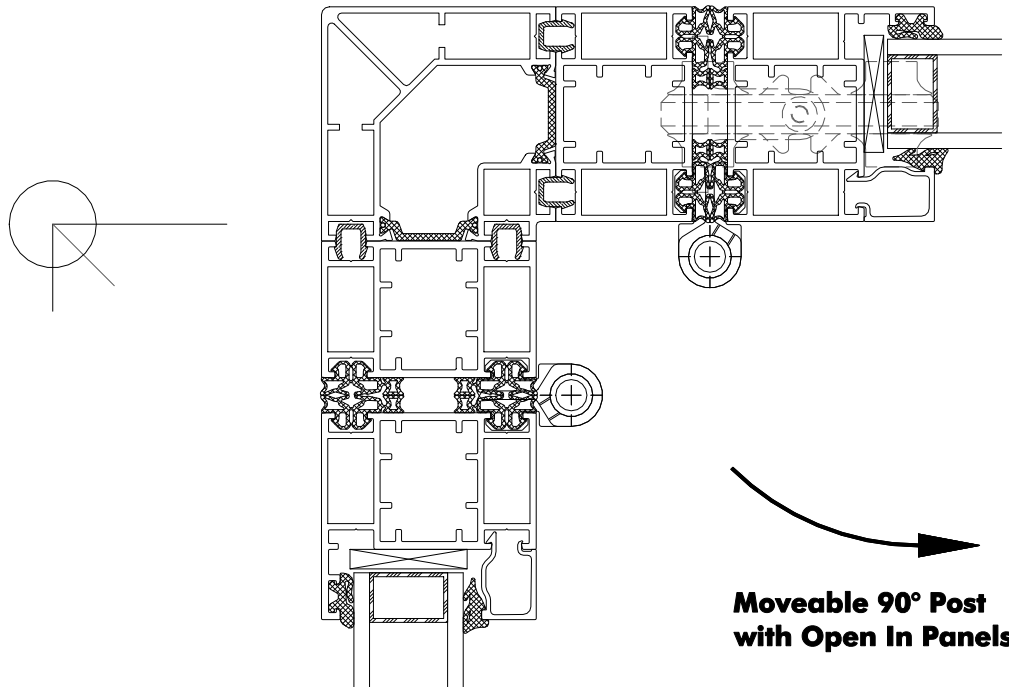

**Moveable 90° Post
with Open In Panels**

Description **Horizontal Section**
Typical Moveable 90° Post Examples

Detail No: **SF50-31**

System: **SF50**

A

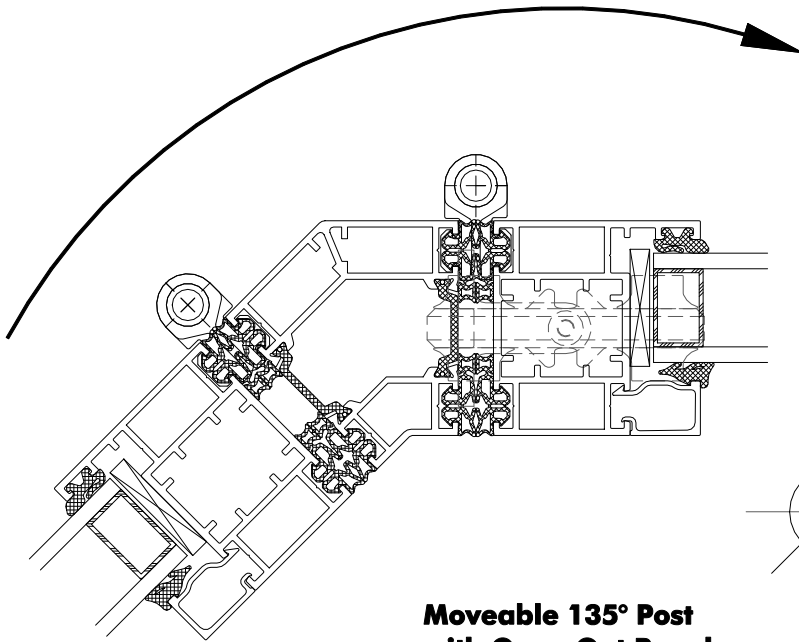

**Moveable 135° Post
with Open Out Panels**

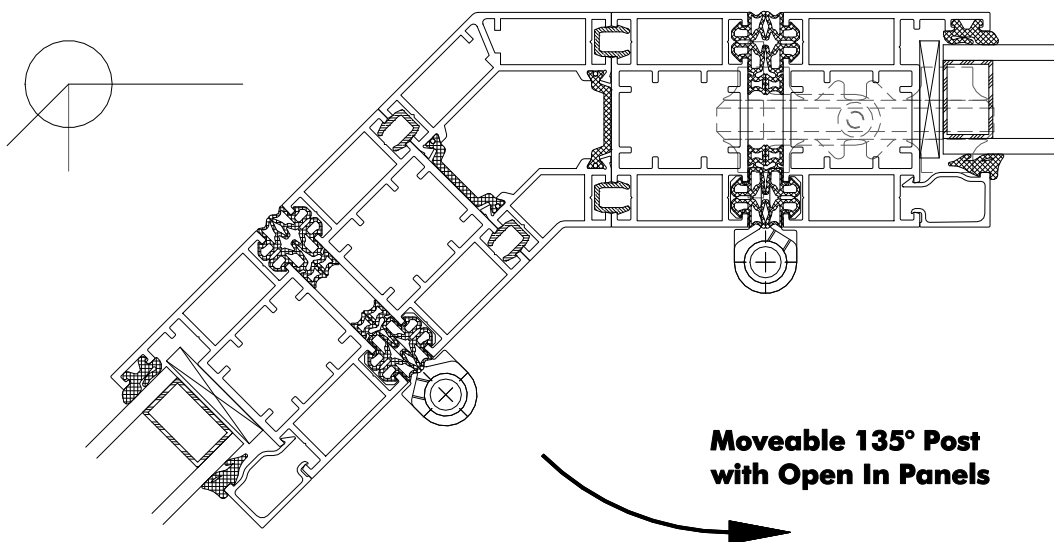

**Moveable 135° Post
with Open In Panels**

Description **Horizontal Section**
Typical Moveable 135° Post Examples

Detail No: **SF50-32**

System: **SF50**

A